

OWNERS MANUAL



2.4m x 2.4m Green Compact Gazebo



MPG-G24-B

CONTENTS

Products & parts.....	3
Assembly Instructions.....	4
Disassembly Instructions.....	6
Instructions to fit optional OZtrail Gazebo accessories.....	7
Warranty.....	9
Correct fitting procedure and conditioning your canopy.....	10
Prolonging the life of your Gazebo.....	11
Important Safety and Care Information.....	12
Understanding Waterproofness.....	14
Spare parts and repair procedures.....	15
Zips.....	19

HELPFUL HINT

OZtrail advises to read your owner's manual fully and assemble your Gazebo soon after purchase. Check that all parts are present and that you familiarise yourself with the assembly and disassembly of the product. If you have any questions, your OZtrail dealer will be happy to help you.

2.4m x 2.4m Green Compact Gazebo

This is the gazebo for those that want the smallest possible pack size for the largest possible gazebo space



240 cm x 240 cm



16 kg



280 cm (max)

FEATURES

- 240 x 240cm ground and canopy coverage
- Longer lasting silver coated UVtex Sun Tough fabric with water repellent treatment
- Portable, quick to erect powder coated frame with no assembly required
- Heavy duty legs and struts provide greater strength and improved water shedding
- 3 position push button height adjustment – 173cm, 183cm and 193cm head clearance
- Easy to handle compact wheeled carry bag for transport and storage
- 1 year manufacturer's warranty

Product Code: MPG-G24-B

Thank you for purchasing a quality OZtrail product. Please keep this Owner's Manual in a safe and dry place as it contains important and helpful information.

- OZtrail Gazebos products are designed as a portable and temporary structure, they are not designed to be a permanent structure. OZtrail Gazebo's are not designed to cover cars or boats.
- Do not leave the Gazebo unattended in heavy rain. In rain make sure water does not pond on the Canopy. The weight of the water could cause breakage and collapse.
- Always secure your Gazebo firmly to the ground ensuring all peg points and guy ropes are utilised and remain firm. In heavy rain or winds remove canopy to avoid damaging the Gazebo.
- Do not fold up the Gazebo with the canopy or accessories still attached. It could be damaged if caught in the scissor action struts.

PLEASE NOTE

Due to our policy of continual product development, specifications, parts and features of the product may vary from details within this Owner's Manual.

The following parts are included

- Gazebo frame
- Gazebo canopy
- Guy ropes
- Pegs
- Carry bag

ASSEMBLY INSTRUCTIONS

HELPFUL HINT

After unpacking the Gazebo, use the check list on page 3 to identify all parts and make sure all parts are present. It is important to fit the canopy correctly to the frame to reduce the chance of water ponding during heavy rain. See page 10 for instructions.

PLEASE NOTE

Although this Gazebo requires no frame assembly and set up is very quick, it requires two people to lift and erect safely. Avoid placing hands near the pinch points of the scissor-action struts during setting up or packing away the Gazebo frame. To prevent damage it is important not to drop the gazebo frame.

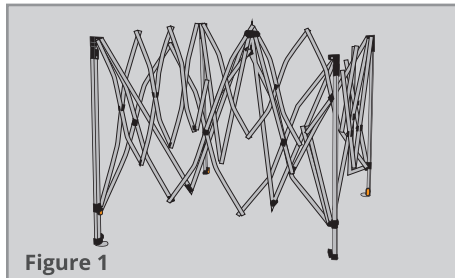

Figure 1

HELPFUL HINT

It is not necessary at any stage of assembly to apply more than a small force on the frame. If a small force is not sufficient to carry out each described step, then re-align the frame and try again.

STEP 1: CHOOSE THE SITE

Select a sheltered level site protected from the wind. Clear away all stones, twigs, etc.

STEP 2: UNPACK THE GAZEBO

Remove the Gazebo frame from the carry bag. With the assistance of at least one other person stand the compressed Gazebo frame on its feet facing the desired position. Standing at diagonally opposite corners, slowly expand each leg making sure the scissor-action struts open evenly and smoothly. It will be necessary to move from leg to leg during the opening of the Gazebo. If the strut seems stiff, do not force the Gazebo frame, check and make sure that you are opening the Gazebo frame square and evenly. Please take care the Gazebo feet are not catching on the ground preventing a smooth opening operation. Continue to expand the Gazebo frame until almost fully expanded as indicated in Figure 1.

STEP 3: FITTING THE GAZEBO CANOPY

When the Gazebo is nearly fully expanded remove the Gazebo Canopy from the carry bag and place it over the roof frame of the Gazebo as indicated in Figure 2. Now secure the Canopy to the Gazebo by attaching the Velcro points at the top of the legs as indicated in Figure 3.

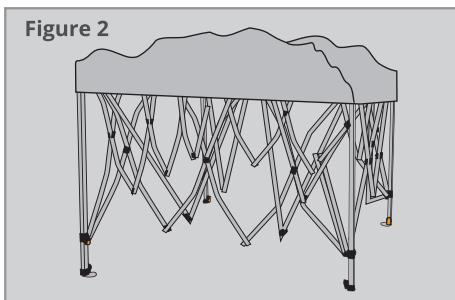

Figure 2

ASSEMBLY INSTRUCTIONS CONT.

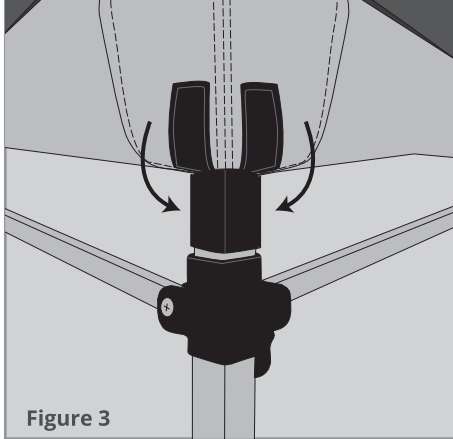

Figure 3

STEP 4: LOCK THE GAZEBO FRAME INTO THE FULLY OPEN POSITION

To fully extend the Gazebo frame and lock into position; grasp the sliding bracket around the top portion of the leg with one hand and with the other hand grasp the Gazebo leg. Pull your hands apart until the push button locks into position as indicated in Figure 4. Avoid placing hands near the pinch points of the scissor-action struts when completing this step.

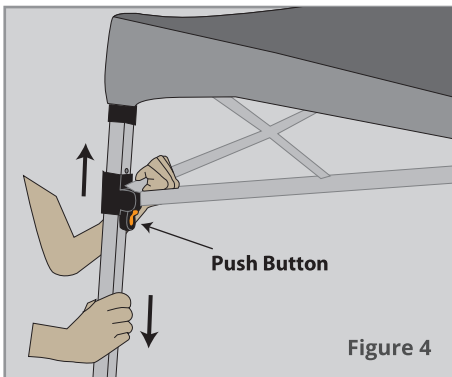

Figure 4

STEP 5: ADJUST THE GAZEBO HEIGHT

Extend the legs to the desired height by grasping above and below the Gazebo leg height adjuster and pulling apart as indicated in Figure 5 until push button locks into position. There are more than one height positions to choose from. Choose your desired height position by pressing in the push button and choosing the desired height setting and ensuring the push button locks into position. Make sure each Gazebo leg is locked into the same height setting.

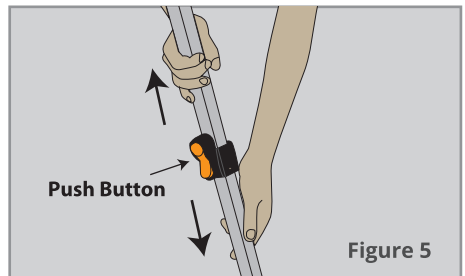

Figure 5

STEP 6: GUY ROPE AND PEG OUT

With the large pegs provided peg the leg base feet to the ground as indicated in Figure 6. With the guy ropes attached to the Gazebo Canopy, make a loop (about 30 - 50cm long) with a slider on the end of the rope and peg out as far as possible from the Gazebo, as indicated in Figure 7. Ensure all peg down points are utilised and all guy ropes are attached firmly and remain firm.

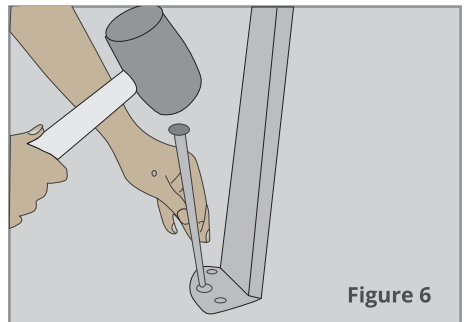
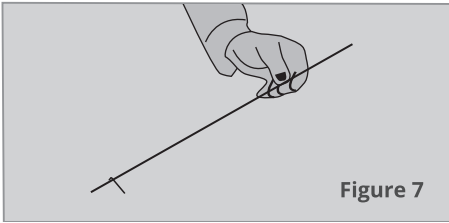

Figure 6

ASSEMBLY INSTRUCTIONS CONT.



PLEASE NOTE

In heavy rain or strong wind the canopy should be removed and in severe conditions the Gazebo should be dismantled.

HELPFUL HINT

Never store your Gazebo damp or dirty. If you have no choice to pack up a damp or dirty Gazebo, make sure you lay it out to air in a cool, dry and shaded place as soon as possible and only pack it away when it is completely dry and clean.

To pack away, remove all accessories and then simply reverse the above process, noting to release the roof hub and leg push button locking mechanisms. Avoid placing hands near the pinch points of the scissor-action struts when packing the Gazebo frame away. Fold the Gazebo canopy in half, third or quarters. The length of the folded canopy should be the length of the canopy storage pocket on the carry bag. To prevent damage it is important not to drop the gazebo frame.

INSTRUCTIONS TO FIT OPTIONAL OZTRAIL GAZEBO ACCESSORIES

WALL KIT ATTACHMENT INSTRUCTIONS

- FREESTYLE GAZEBO WALL KITS ARE SUITABLE FOR ALL 2.1m WALL LENGTH MODELS.
- COMPACT GAZEBO WALLS KITS ARE SUITABLE FOR ALL 2.4m & 4.8m WALL LENGTH MODELS.
- DELUXE GAZEBO WALL KITS ARE SUITABLE FOR ALL 3.0m & 6.0m WALL LENGTH MODELS.
- MEGA GAZEBO WALL KITS ARE SUITABLE FOR ALL 4.5m WALL LENGTH MODELS.

- You will require 4 wall kits to enclose the entire 2.1 x 2.1m Freestyle Gazebo, 2.4 x 2.4m Compact Gazebo, 3.0 x 3.0m Deluxe Gazebo and 6 wall kits to enclose the 4.8 x 2.4m Compact Pavilion, 6.0 x 3.0m Deluxe Pavilion.
- You will require 4 wall kits to enclose the entire 4.5 x 4.5m Deluxe King Gazebo and 2 wall kits to enclose the 4.5m walls on the Mega Gazebo and Mega Pavilion.
- On some Gazebo models the walls will not touch the ground when the Gazebo is set to the maximum height.

STEP 1:

Locate the top corner of the wall. The top of the wall has a hook sewn into each corner and Velcro patches along the outside edge.

STEP 2:

Using the hooks, connect each of the top corners to the metal ring located at the top of the Gazebo leg, then attach the Velcro from the wall to the Gazebo.

STEP 3:

Peg down each side of the wall kit using the pegs provided.

STEP 4:

Tie the wall kit to the legs of the Gazebo using the ties located about halfway up each side of the wall kit.

STEP 5:

To add another wall kit, zip it to the existing wall and repeat the above steps.

HALF HEIGHT SOLID WALL KIT ATTACHMENT INSTRUCTIONS

STEP 1:

Assemble the 3 section pole and slide it gently through the pole sleeve that runs along the top of the wall.

STEP 2:

Using the claps at each end the pole, connect the claps firmly but not tight to the leg upright at approximately halfway up the leg. Checking the hooks on the bottom corners of the wall can reach and attach to the leg feet.

STEP 3:

Now attach the hooks to the feet and gently re-adjust the claps to make the wall sit secure and neatly. Make sure the claps are firm but not tight.

STEP 4:

Locate the Velcro tabs on the wall, found just below the pole claps. Secure the wall kit to the legs of the Gazebo using these Velcro tabs.

INSTRUCTIONS TO FIT OPTIONAL OZTRAIL GAZEBO ACCESSORIES

REMOVABLE AWNING KIT ATTACHMENT INSTRUCTIONS

STEP 1:

Identify the two side support frame arms, the fabric awning and the front spreader pole.

STEP 2:

Attach the two side support frame arms to the upright legs of the Gazebo approximately 150mm below the base of the canopy.

STEP 3:

Align the fabric awning and insert the corner webbing pockets of the awning onto the ends of the side support arms. With the help of another person slide the spreader pole through the sleeve that runs across the front edge of the fabric awning. Attach the spreader pole to the support arms and tension.

STEP 4:

Attach the corner hooks on the fabric awning to the ring on the corner hub located at the top of the Gazebo legs. Now align and join the Velcro tabs along the edge of the awning fabric and Gazebo roof fabric. Check the awning is firm, but not tight and remains firm.

HELPFUL HINT

It is not necessary at any stage of assembly to apply more than a small force on the frame. If a small force is not sufficient to carry out each described step, then re-align the frame and try again.

GUTTER SYSTEM KIT ATTACHMENT

STEP 1:

Position two 3m x 3m OZtrail Gazebos side by side.

STEP 2:

Unpack and align the Gutter System.

STEP 3:

Locate the Velcro on the inside edge of the adjoining canopies.

STEP 4:

Locate the corresponding Velcro on the Gutter System.

STEP 5:

Simply attach the Gutter System by joining the Velcro on the Gutter and the Canopy.

STEP 6:

The hose can be attached to the leg of the Gazebo and the flow directed away from the Gazebo.

INNER KIT ATTACHMENT INSTRUCTIONS

STEP 1:

Ensure the site under the Gazebo is level and clear of all stones, twigs, etc.

STEP 2:

Unpack the contents of your Gazebo inner kit. Unfold the fabric and layout with the floor against the ground and the wall and roof fabric facing up.

STEP 3:

On each corner of the floor there is an elasticised hook attached. Connect this hook to the base of the frame upright poles. Located midway along the side of the floor there are peg out webbing loops. With the pegs provided peg out these webbing loops firm but not tight.

STEP 4:

On each corner of the roof there is an elasticised hook attached; connect this hook to the top of the frame's upright poles. Located midway along the edge of the roof there are "J" hooks on webbing loops; connect these "J" hooks to the scissor action struts of the Gazebo frame. Midway up the wall corners there are ties; wrap these ties around the frame's upright poles and tie together, firm but not tight.

Warranty

OZtrail warrants this product against defects for a period of one year from the date of purchase. OZtrail will repair or replace the product, at its discretion, should a warrantable defect arise within the warranty period. If the exact model is unavailable a model of equivalent nature will be substituted at our discretion. This warranty excludes faults and failures caused by improper use and abuse; fair wear and tear; or failure to follow instructions regarding care and maintenance. Products used for a commercial nature are not covered by this warranty against defects. A warranty may be claimed by returning the product to its place of purchase, with a detailed proof-of- purchase clearly showing the date and detail of the purchase. You may also contact OZtrail Leisure Products, by phone: 07 3193 1110, or in writing: PO Box 1110, Eagle Farm QLD 4009, by email: warranty@oztrail.com.au. The benefits under OZtrail's warranty against defects are in addition to other rights and remedies under law in relation to goods.

Our goods come with guarantees that cannot be excluded under the Australian Consumer Law. You are entitled to a replacement or refund for a major failure and for compensation for any other reasonably foreseeable loss or damage. You are also entitled to have the goods repaired or replaced if the goods fail to be of acceptable quality and the failure does not amount to a major failure.

For more detailed information and an explanation of these terms see www.oztrail.com.au/warranty

INSURANCE, YOUR PROTECTION AGAINST THE UNEXPECTED

Most people have product problems from unexpected sources. Extreme weather is a good example of an unexpected problem. Make sure you consider including the Gazebo on your Home and Contents Insurance policy.

PLEASE NOTE

Accessories shown may be for display purposes only and not included with the product. Due to our policy of continual product development, specifications and features of this product may vary from what is stated.

CORRECT FITTING PROCEDURE AND CONDITIONING YOUR CANOPY

Once you have purchased your Gazebo, it is important to learn how to condition the canopy and to fit the canopy correctly to minimise the risk of water collecting on the canopy. Simply pitch your Gazebo and wet the canopy down with your garden hose until the fabric and all seams are saturated. Pay particular attention to the seams - the thread swells when wet and blocks the needle holes. The needle holes also shrink around the thread. The fabric also benefits from this because the fibre swells into the weave and the waterproof treatment settles within the fabric. Let the canopy dry completely before repeating this wetting and drying process until there is no leakage during hosing. Always pack your canopy away dry.

It is important to note during this process the flow of water off the canopy and the importance of fitting the canopy correctly and avoiding panels of the canopy without tension. During rain roof panels without tension will allow water to collect into ponds instead of running off. To avoid water collecting ensure the Gazebo is level and the corners of the canopy are fitted without gathered fabric. Ensure the Velcro on the canopy aligns correctly with the Velcro at the top of the legs as indicated in Figure 8.

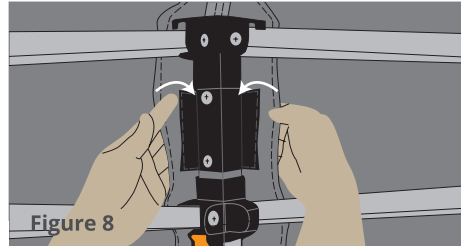

PROLONGING THE LIFE OF YOUR GAZEBO

PLEASE NOTE

OZtrail Gazebos are designed for temporary use only. Although our fabrics are treated for UV resistance, continuous exposure to sun light will reduce the life of the fabric. Fading of colour is an early warning sign. OZtrail Gazebos are not designed as permanent dwellings or structures.

- Do not leave the Gazebo unattended in heavy rain. In rain make sure water does not pond on the Canopy. The weight of the water could cause breakage and collapse.
 - Always secure your Gazebo firmly to the ground ensuring all pegpoints and guy ropes are utilised and remain firm. In heavy rain or winds remove the canopy to avoid damaging the Gazebo.
 - Do not fold up the Gazebo with the canopy or accessories still attached. It could be damaged if caught in the scissor action struts.
 - Never store a damp or dirty Gazebo, as mildew and corrosion can form. Always allow the Gazebo to dry completely before packing and stowing. If mildew occurs, use a soft bristle brush or sponge with mild detergent to clean it off. After beach use or wet weather treat all zips, poles and pegs with silicon spray.
 - Sometimes after lots of use the zipper coil on Gazebo accessories can burst open or does not close. This could be due to wear or metal fatigue. The problem can be easily fixed, see the instructions on page 19.
 - Always carry a roll of heavy duty tape for simple repairs to small rips, cuts and ash burns. This not only blocks the hole, it will prevent further tearing.
- When removing pegs, do not use the webbing or corner of the wall as your handle. Either use another peg, a peg remover or the claw of a hammer hooked under the peg to remove them.

MATERIALS:

Frame – Steel with plastic componentry
Canopy – Polyester

CARE INSTRUCTIONS:

Wipe down all surfaces with fresh water after use. To remove marks, use a soft brush or sponge with fresh water and mild detergent only and rinse with fresh clean water. Allow to dry thoroughly. After beach use or wet conditions treat all zips and metal components with silicon spray. Never pack away damp, dirty or wet.

IMPORTANT SAFETY AND CARE INFORMATION

Please read before setting up your gazebo

GAZEBO USE - SAFETY HABITS

Fabrics used in the construction of OZtrail Gazebos are treated for fire retardant properties. This treatment reduces the rate at which the fabric will burn. The fire retardant fabric will still burn if it comes into direct contact with a flame or extreme heat.

The application of any foreign substance to the fabric such as some water proofing treatments or insect sprays may render the fire retardant treatment process ineffective.

The following pages cover several safety tips that will help you avoid some of the common hazards encountered when using a Gazebo.

TO PREVENT INJURY CAUSED BY GAS POISONING OR SUFFOCATION WHEN USING YOUR GAZEBO WITH INNER TENT KITS OR WALL KITS

- Be aware gas, fumes or lack of oxygen within the Gazebo could result in unconsciousness, brain damage and even death.
- Always ensure your Gazebo is well ventilated. When using the optional solid wall kits or inner tent, do not close every window or wall. A well ventilated Gazebo not only maintains healthy Oxygen levels but also reduces condensation build up inside the Gazebo.
- Do not use fuel burning, oxygen consuming devices inside the Gazebo. This includes candles, gas lanterns, kerosene lamps, stoves, cooking and heating appliances.
- Do not use gas appliances of any kind inside the Gazebo.

TO PREVENT INJURY CAUSED BY FIRE

- Do not position the Gazebo near a camp fire or any other flame source
- Do not use candles, matches or any other flame source near the Gazebo canopy
- Only use recommended water repellent compounds on the Gazebo canopy
- Do not spray tent fabrics with insecticides



TO PREVENT INJURY CAUSED BY ELECTRICITY

- Always exercise care when using electricity and electric lighting in and near Gazebos. Only use 12 volt lighting.



IMPORTANT SAFETY AND CARE INFORMATION CONT.

To prevent injury caused by your incorrect site selection of Your gazebo



- Do not position your Gazebo on an area that could get flooded



- Do not position your Gazebo near cliffs in case of collapse or rock fall



- Do not leave your Gazebo erected in strong weather conditions



- Do not position your Gazebo under trees with dead branches or under trees known to drop branches

UNDERSTANDING WATERPROOFNESS

KNOW YOUR GAZEBO

OZtrail Gazebos are manufactured from waterproof and water repellent fabrics. However, with the addition of seams, zips and other desirable features, a temporary Gazebo will not be as waterproof as other solid structures.

The following are common examples of how water can enter a Gazebo:

CONDENSATION

When warm moist air meets cooler air, condensation occurs. The Gazebo canopy forms an impermeable layer between the inside and outside conditions. The moisture inside the Gazebo condenses on the fabric. Sometimes in cold conditions it appears that the fabric is leaking when in fact the cause is condensation. Condensation can be reduced if the Gazebo is well ventilated.

ZIPS

All care is taken in the design to cover zips. At times wind driven rain could force water under the flaps and through the zips.

STRUCTURAL INTEGRITY

A well-pitched Gazebo (see page 10, CORRECT FITTING PROCEDURE AND CONDITIONING YOUR CANOPY) on level ground is structurally strong and most waterproof. During prolonged periods of rain and wind it may be necessary to tighten guy lines and reset the leg pegs and check to clear drainage of the roof panels. Sagging and incorrect pitching weakens the Gazebo structure and could allow water to pool on the canopy placing undue forces on the Gazebo causing leaking and breakages.

SPARE PARTS AND REPAIR PROCEDURES

METAL STRUT AND HUB REPLACEMENT

With age, wear and tear or the forces of nature, Gazebos like all products with moving parts will require the need to replace a metal strut mechanism or the plastic connecting hubs. Most parts for your OZtrail Gazebo are available from OZtrail.

FREESTYLE AND ELITE MODELS

Tools required (not provided) as indicated in Figure 9.

- 1 x Phillips screwdriver

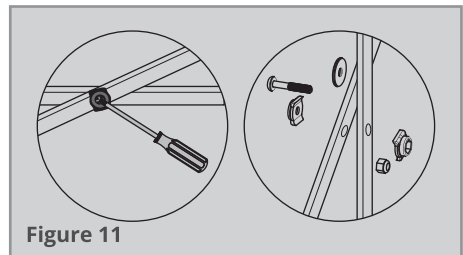
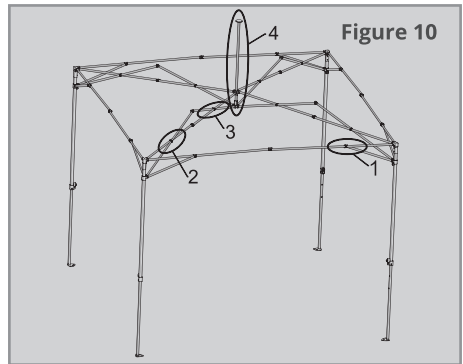
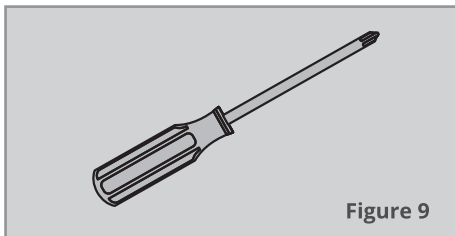

To replace cross action struts, partially extend the Gazebo frame and remove screws taking care not to lose any parts.

Ensure you have the correct strut as the Elite and Freestyle Gazebo models have four types of strut assemblies as indicated in Figure 10. 1) Side strut with support arm, 2) Cross action roof strut that extends from the corner pole, 3) Cross action roof strut that extends from the centre pole, and 4) Centre roof pole.

Remove the damaged hub or metal strut as indicated in Figure 11. Align the new hub or metal strut, reinsert the screws and tighten with screw driver and spanner (if required).

COMPACT AND STANDARD MODEL

Tools required (not provided) as indicated in Figure 12

- 1 x Allen key
- 1 x open ended spanner

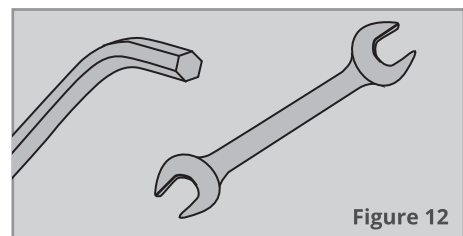

SPARE PARTS AND REPAIR PROCEDURES

Partially extend the Gazebo frame and undo the bolts taking care not to lose any parts.

Ensure you have the correct strut as the Compact and the Standard Gazebo models have three types of strut assemblies as indicated in Figure 13. 1) Corner strut that attaches to the poles and 2) Mid strut that fits between the two corner struts and 3) Roof struts that extend from the corner to the Top Dome Hub and come complete with the two support arms that extend down to the bottom piece of the corner scissor struts.

Remove the damaged hub or metal strut as indicated in Figure 14. Be careful to keep the screws as often these can be used again. Align the new hub or metal strut, reinsert the screws and tension with allen key and spanner.

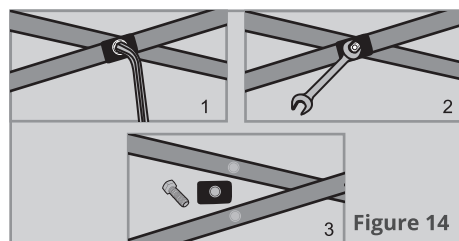
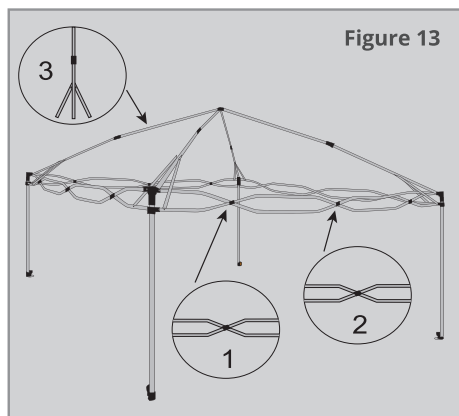

DELUXE AND MEGA MODELS

Tools required (not provided) as indicated in Figure 15

- ✓ 1 x Phillips screwdriver

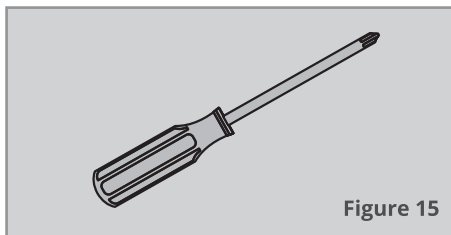

To replace the scissor action struts as indicated in Figure 16, partially open the gazebo to enable easy access to the 3 Way Hubs that connects the Struts and the Corner hubs that attaches the struts to the Corner Legs.

Remove the damaged hub or scissor action metal strut as indicated in Figure 17. Be careful to keep the screws as often these can be used again. Align the new hub or scissor action metal strut, reinsert the screws and tension with screwdriver.

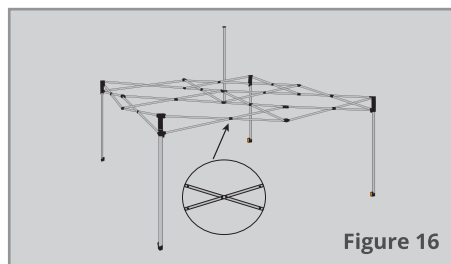

SPARE PARTS AND REPAIR PROCEDURES

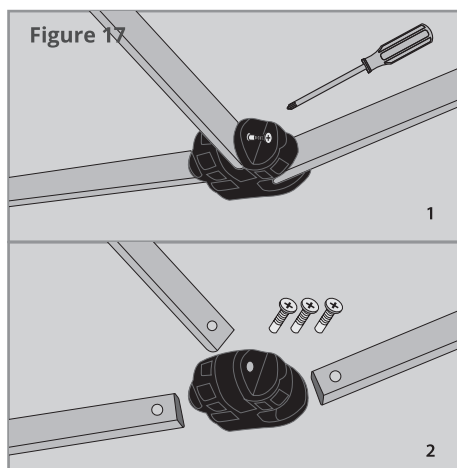

REPLACING DAMAGED LEG COMPONENTS

Tools required (not provided) as indicated in Figure 18

- 1 x Phillips screwdriver

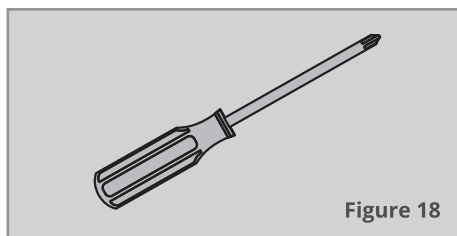

Either a lower half or complete new Gazebo leg as indicated in Figure 19 can be replaced.

If it is only the lower part of the leg that is required this also can also be purchased as a spare part and comes complete with all necessary fittings. The lower leg section can be simply replaced by sliding the broken part out of the main body of the leg by releasing the clips that hold the height adjustment in place. The replacement can then be slid into the leg and clipped into place. Care needs to be taken to ensure the holes for the height adjustment are aligned with the pin.

If the pin at the top of the leg that holds the struts up does not pop out it has probably moved inside the leg. If this happens, lie the gazebo on its side and remove the screws holding it in place (screws also hold the ring clips for the walls).

This will allow access to the pin via the top of the leg using a hooked piece of wire to manoeuvre the spring clip back into place.

The complete new Gazebo leg comes with all fittings to allow easy replacement. Remove the damaged leg as indicated in Figure 20. Be careful to keep the screws as often these can be used again. Align the new leg, reinsert the screws and tension with screwdriver.

All the plastic components for the leg are available as spare parts.

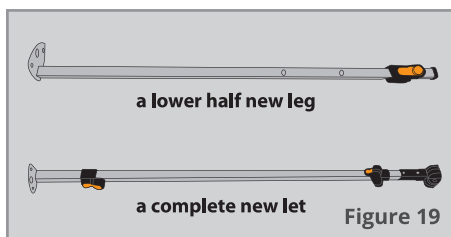

SPARE PARTS AND REPAIR PROCEDURES

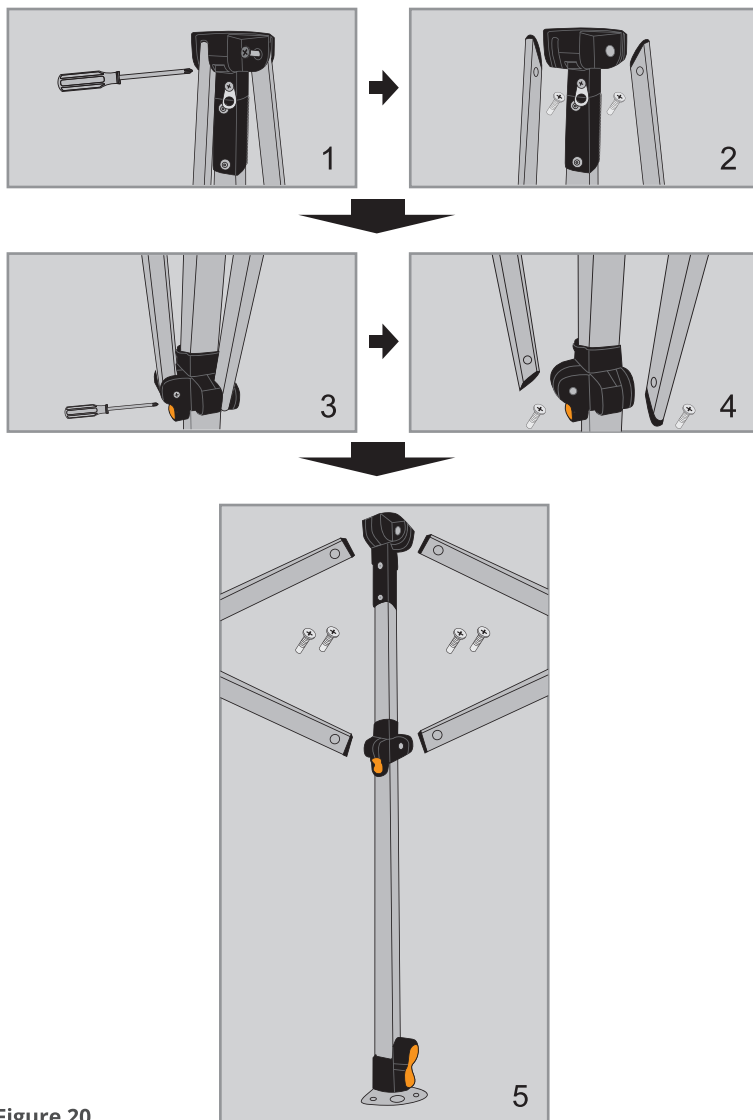

Figure 20

Zips

REDUCING THE RISK OF JAMMING FABRIC IN THE ZIP

- When using the zip, hold the pull-tab between your thumb and forefinger with your thumb facing you.
- As you are closing the zip clear the way in front and under the zip slider using the back of your hand, and cup the zip slider underneath with your remaining 3 fingers. Use this action for opening or closing. Keep the fabric clear of the zip slider - zip and unzip slowly.

WHAT TO DO IF THE ZIPPER GETS CAUGHT

- Pull the fabric bit by bit out of the slider. Do not try and pull all the fabric in one go. Do not force the slider or the fabric.

IF THE SLIDER DOES NOT CLOSE THE ZIPPER PROPERLY

- With use, the jaws of the zip slider can open ever so slightly. When this occurs the slider does not compress the zip teeth or coil tightly enough and the zip bursts open or does not close.
- Undo the zip and with the slider at the end of the zip lightly crimp the jaws of the slider together. Try top to bottom axis first and then side to side axis.

CRIMPING A ZIP-SLIDER

- The most common reason why zips burst open is that the zip slider does not close the coil tightly enough. Wear and tear may cause the gap marked A to open up, as indicated in Figure 23.
- By simply “crimping” the slider together at points B & C with a pair of pliers, this solves the problem most of the time. Crimping in other planes is worth a try if B & C does not work. This is to be done when the zip slider is still attached to the zip in the open position, as indicated in Figure 21.

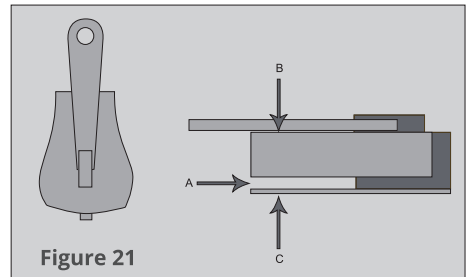



See our website for the full OZtrail range or

 facebook.com/OZtrailAustralia.

Made in China
Designed & Imported by:
OZtrail Leisure Products
71 Charles Ulm Place, Eagle Farm
QLD 4009, AUSTRALIA

www.oztrail.com