

OWNERS MANUAL



Family 6



DTE-FA06-D

CONTENTS

Products & parts.....	3
Assembly Instructions.....	4
Disassembly Instructions & Folding Instructions.....	7
Warranty.....	8
Prolonging The Life Of Your Tent/ Shelter.....	9
Important Safety & Care Information.....	10
Replacing the Shock-Cord in Tent Poles.....	12
Understanding Waterproofness.....	14
Zips.....	15

HELPFUL HINT

OZtrail advises to read your owner's manual fully and assemble your tent before going camping to ensure all parts are present and to become familiar with the assembly of your tent.

Family 6

A family tent that has a cavernous internal space and plenty of awning options

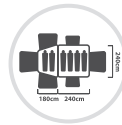

420 cm x 240 cm



13 kg



200 cm

FEATURES



Fast Set up

- Easy to set up Portico™ pole system used throughout the tent
- Includes shock corded, fast-assembly, anti-shear DuraPlus fiberglass poles
- J Hooks quickly attach to tent poles and also add extra rigidity



Strong & Durable

- Heavy duty coated rip stop 68 denier UVTex2000® polyester Fly
- Velcro™ fly tabs lock the tent and guy ropes together structurally
- Welded heavy duty PE floor with reinforced corner patches on peg tab points



Weather Resistant

- PU coated UVTex2000® Fly fabric resists the penetrating effects of the rain
- Factory taped Fly seams and storm flaps on all zippers for added security
- Welded heavy duty PE bucket floor elevates floor seams above ground level



Climate Protection

- Ultra fine No-See-Um insect proof mesh keeps out the smallest insects
- Excellent air flow from large front & rear doors & side windows
- Window & door awnings control temperature, ideal for cool to tropical conditions



User Friendly

- Lightweight design packs away quickly & easily into a compact carry bag
- Efficient storage with two easy to locate sidewall organiser pockets
- Prepared for 12V with centrally located light attachment point

Product Code: DTE-FA06-D

Thank you for purchasing a quality OZtrail product. Please keep this Owner's Manual in a safe and dry place, it contains important and helpful information.

The following parts are included for Product Code: DTE-FA06-D

PART DESCRIPTION

- ✓ 3 x roof fibreglass poles 1
- ✓ 6 x steel wall poles 2
- ✓ 2 x steel awning poles
- ✓ 23 x pegs
- ✓ 8 x guy ropes
- ✓ 1 x Tent carry bag
- ✓ 1 x Inner tent
- ✓ 1 x Fly sheet
- ✓ 1 x Pole bag
- ✓ 1 x Peg bag

PLEASE NOTE

Due to our policy of continual product development, specifications, parts and features of the product may vary from details within this Owners Manual.

HELPFUL HINT

We recommend that you set up this product before you leave for your trip. Check that all parts are present and that you familiarise yourself with the assembly and disassembly of the product. If you have any questions, your OZtrail dealer will be happy to help you.

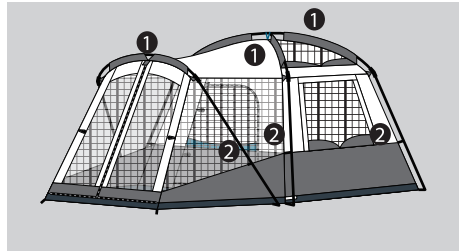

ASSEMBLY INSTRUCTIONS

STEP 1: CHOOSE THE SITE

Select a sheltered camp site protected from the wind that will not allow water to pond under the tent floor. Clear a level area of all stones, twigs, etc.

STEP 2: LAY OUT THE TENT

Unpack the contents of your tent. Lay out the inner of your tent ensuring that you have the doors facing in the direction you require.

HELPFUL HINT

1. After unpacking the tent or shelter, use the check list on **page 3** to identify all parts and make sure all parts are present.
2. It is important to condition your tent or shelter before use. See **page 9** for instructions.

STEP 3: PEG DOWN THE TENT

Peg out the corners of the inner tent. These peg points are indicated in **Figure 1**. Anchor the tent to the ground by inserting the pegs through the loops around the base of the tent at an angle of 45 degrees as indicated in **Figure 2**. Firm but not tight. As you work from one peg point to the other around the tent base pull the floor firmly, but not tight.

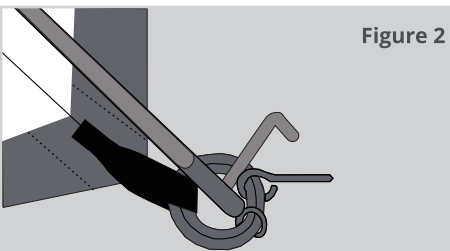
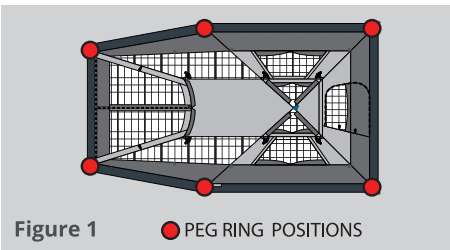

STEP 4: ASSEMBLE THE POLES

Assemble all poles making sure each pole junction is securely connected. Place the assembled poles side by side for easy identification, see **Figure 3**.

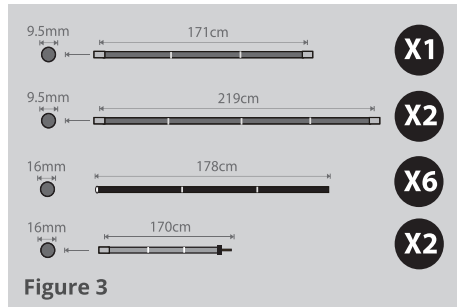

STEP 5: INSTALLING THE ROOF POLES

Select the two longest fibreglass roof poles and install by sliding it through the pole sleeves that run diagonally from corner to corner over the apex of the rear bedroom, as indicated in **Figure 4**. Insert the ends of the roof fibreglass poles into the narrow openings of the 2-way hubs that are pre-attached to the inner tent.

Select the remaining fibreglass pole and install by sliding through the pole sleeve that runs across the roof at the front door of the screen room. Insert the ends of the pole into the narrow openings of the 2-way hubs that are pre-attached to the inner tent.

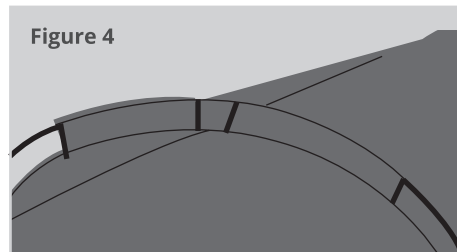

ASSEMBLY INSTRUCTIONS CONT.

HELPFUL HINT

Do not force the pole through the sleeves as this may damage the sleeve and could break the pole. Check to ensure the pole does not snag when sliding it through the sleeve.

STEP 6: STANDING UP THE TENT

Select one of the six steel wall poles. Insert one end of the pole into the remaining opening of the 2-way hub and insert the opposite end of the pole onto the corresponding pin and ring assembly at the base of the tent, as indicated in **Figure 2**. The correct pin is not always directly below, the steel wall pole for the front living area sits inclined along the side wall at approximately 45 degrees. Repeat this process for the remaining five steel wall poles. The tent will stand up during this process.

Connect the J-Hooks attached to the inner tent onto the poles, see **Figure 5**. Peg out all remaining peg points around base of tent.

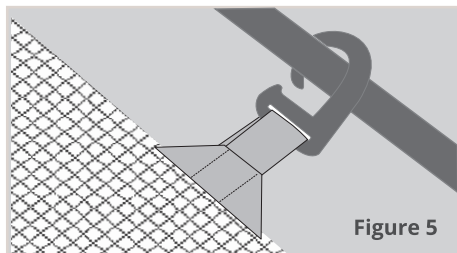

Figure 5

HELPFUL HINT

Before attempting this step it helps to open the doors of the tent. This allows for the air to enter into the tent as you raise it.

STEP 7: ATTACHING THE FLY SHEET

Lay the fly sheet out along the side of your tent. Ensure that you have the front and the back aligned correctly. Raise the fly sheet up and carefully draw it over the top of your tent. Do this slowly to avoid snagging the fly. Once the fly sheet is on top of your tent, you can now securely attach all of the Posibrace™ Velcro™ reinforcing points on the underside of the fly sheet around the corresponding poles, see **Figure 6**. Now connect the hooks along the base of the fly to the corresponding ring around the base of the inner tent, see **Figure 7**.

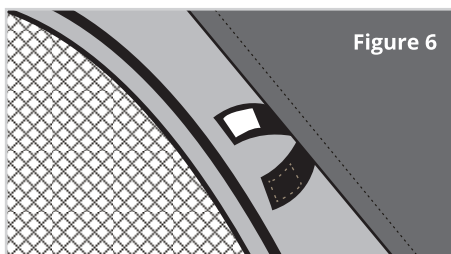

Figure 6

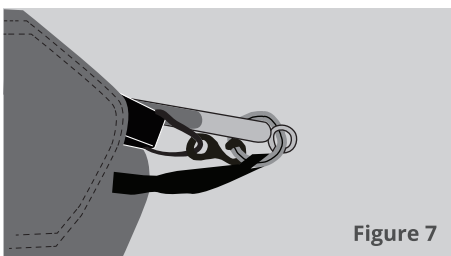
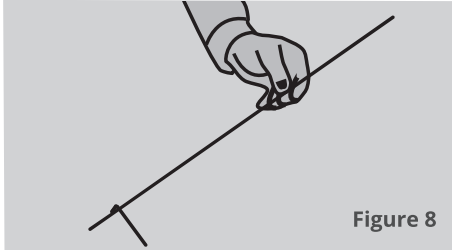

Figure 7

STEP 8: GUY ROPE AND PEG OUT

Ensure all guy ropes and peg points of the fly and tent are utilised. Make a loop (about 30 – 50cm long) with a slider on the end of the rope and peg out as far as possible from the tent, see **Figure 8**. Ensure all guy ropes are attached firmly and remain firm, as indicated in **Figure 9**. If required, use remaining steel awning poles to set up front, side or rear awnings.

ASSEMBLY INSTRUCTIONS CONT.



PLEASE NOTE

In severe conditions the tent should be dismantled.

DISASSEMBLY INSTRUCTION

STEP 1:

On the fly close windows, awnings and doors, release guy ropes and Posibrace™ Velcro™ points that attach the fly to the poles and unhook all base hooks. You can now remove fly from tent. Lay fly flat on ground and fold fly in half, third or quarters. The width of the folded fly should be the length of the pole bag, see **Figure 10**.

STEP 2:

Zip close doors and windows, collapse the tent by removing and disassembling the poles in the reverse order of the assembly instructions. Place the poles in the pole carry bag and tie shut.

STEP 3:

Remove pegs with a claw hammer or peg puller. Do not remove pegs from the ground by pulling on tent base as this may cause damage to the tent.

STEP 4:

Spread the tent out flat with all loose fabric folded within the edges of the tent base. Try to flatten the tent as much as possible.

STEP 5:

Fold the tent in half, third or quarters. The width of the folded tent should be the length of the pole bag, see **Figure 10**.

STEP 6:

Lay the folded fly over the folded inner tent. Beginning at the back portion of the fly and inner tent bundle roll forward firmly allowing trapped air to escape. It may help to use the bag of tent poles as a rolling pin ensuring the tent edges are kept straight as you roll.

STEP 7:

Once the tent bundle is rolled up, tie straps around it and place into tent carry bag with peg bag, instruction booklet and other miscellaneous parts. If the tent won't fit into carry bag, unroll and reroll more tightly.

HELPFUL HINT

Never store your tent damp or dirty. If you have no choice to return home from your camping trip with a damp or dirty tent, make sure you lay it out to air in a cool, dry and shaded place as soon as possible and only pack it away when it is completely dry and clean.

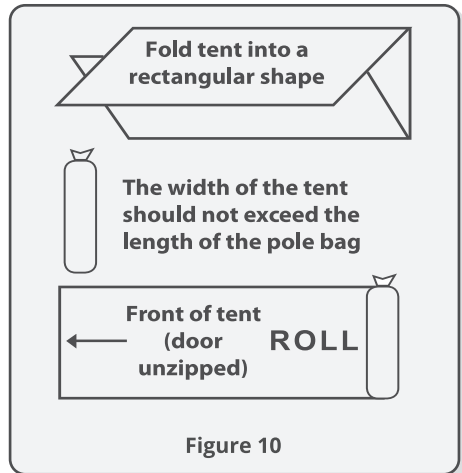

WARRANTY

OZtrail warrants this product against defects for a period of one year from the date of purchase. OZtrail will repair or replace the product, at its discretion, should a warrantable defect arise within the warranty period. If the exact model is unavailable a model of equivalent nature will be substituted at our discretion. This warranty excludes faults and failures caused by improper use and abuse; fair wear and tear; or failure to follow instructions regarding care and maintenance. Products used for a commercial nature are not covered by this warranty against defects. A warranty may be claimed by returning the product to its place of purchase, with a detailed proof-of-purchase clearly showing the date and detail of the purchase. You may also contact OZtrail Leisure Products, by phone: 07 3193 1110, or in writing: PO Box 1110, Eagle Farm QLD 4009, by email: warranty@oztrail.com.au. The benefits under OZtrail's warranty against defects are in addition to other rights and remedies under law in relation to goods.

Our goods come with guarantees that cannot be excluded under the Australian Consumer Law. You are entitled to a replacement or refund for a major failure and for compensation for any other reasonably foreseeable loss or damage. You are also entitled to have the goods repaired or replaced if the goods fail to be of acceptable quality and the failure does not amount to a major failure.

For more detailed information and an explanation of these terms see www.oztrail.com.au/warranty

PLEASE NOTE

Accessories shown may be for display purposes only and not included with the product. Due to our policy of continual product development, specifications and features of this product may vary from what is stated.

AVOIDING MOULD AND MILDEW

You should always pack your products both clean and completely dry. In many climates there is a risk of mould or mildew damage to materials that are not packed away in a dry state, this condition is not covered by the warranty. After each camping trip, clean your products with warm soapy water and allow them to dry completely after rinsing them with fresh water.

CARING FOR YOUR SHOCK CORD

Shock cord is designed to help you keep your tent poles organised and to allow quick assembly of the poles. Over stretching the cord or dropping the poles will cause shock cord failure and this condition is not covered by the warranty.

INSURANCE, YOUR PROTECTION AGAINST THE UNEXPECTED

Most people have product problems from unexpected sources. Extreme weather is a good example of an unexpected problem. Make sure that you place your expensive camping products on your Home and Contents Insurance policy. Most good insurers will cover the storm damage to your tent or other products that falls outside of warranty.

PROLONGING THE LIFE OF YOUR TENT/ SHELTER

- Temporary use only. Although our fabrics are treated for extra UV resistance, continuous exposure to sun light will reduce the life of the fabric. Fading of colour is an early warning sign. OZtrail products are not designed as permanent dwellings or structures.
- During rain always lower awnings to avoid water ponding.
- Never store a wet and/or soiled tent/shelter; as mildew and corrosion can form. Always allow the tent to dry completely before packing and stowing. If mildew occurs, use a soft bristle brush or sponge with mild detergent to clean it off. After beach use or wet weather treat all zips, poles and pegs with silicon spray.
- The elastic shock cord within the poles is provided for easy assembly of the poles. The shock cord is not required for any structural reason. The poles and tent perform perfectly well without the shock cord. Age, over stretching and mishandling may cause failure. Shock cord is not covered by warranty. It's easy to replace, see the instructions on **page 12**.
- Sometimes the zipper coil bursts open or does not close. This could be due to wear or metal fatigue. The problem can be easily fixed, see the instructions on **page 15**.
- Always carry a roll of heavy duty tape for simple repairs to small rips, cuts and ash burns. This not only blocks the hole, it will prevent further tearing. Heavy Duty tape is also helpful for emergency pole repairs and many other uses around the camp site.
- When removing pegs, do not use the webbing or corner of the tent as your handle. Either use another peg, a peg remover or the claw of a hammer hooked under the peg to remove them.

HELPFUL HINT

CONDITIONING YOUR NEW TENT

Once you get your new tent home, it is important to condition the tent. Simply pitch your tent and wet it down with your garden hose until the fabric and all seams are saturated. Pay particular attention to the seams - the thread swells when wet and blocks the needle holes. The needle holes also shrink around the thread. The fabric also benefits from this because the fibre swells into the weave and the waterproof treatment settles within the fabric. Let the tent dry completely before repeating this wetting and drying process until there is no leakage during hosing. Always pack your tent away dry.

MATERIALS:

Pole: Fibreglass and steel

Tent: PE floor with polyester walls and fly

CARE INSTRUCTIONS:

To remove marks, use a soft brush or sponge with fresh water and mild detergent only and rinse with fresh clean water. Allow to dry thoroughly. Never pack away damp, dirty or wet. After beach use or wet conditions wipe down all metal components and zips using fresh water, dry thoroughly and treat with silicon spray.

IMPORTANT SAFETY AND CARE INFORMATION

Please read before setting up your tent/shelter

CAMP SAFE - SAFETY HABITS

Fabrics used in the construction of OZtrail tents/shelter are treated for fire retardant properties. This treatment reduces the rate at which the fabric will burn. The fire retardant fabric will still burn if it comes into direct contact with a flame or extreme heat.

The application of any foreign substance to the fabric such as some water proofing treatments or insect sprays may render the fire retardant treatment process ineffective.

The following pages cover several safety tips that will help you avoid some of the common hazards encountered on a camping trip.

TO PREVENT INJURY CAUSED BY GAS POISONING OR SUFFOCATION

- Gas, fumes or lack of oxygen within the tent/shelter could result in unconsciousness, brain damage and even death.
- Always ensure your tent/shelter is well ventilated. Even on the coldest night do not close every vent, window and door. A well ventilated tent not only maintains healthy oxygen levels but also reduces condensation build up inside the tent.
- Do not use fuel burning, oxygen consuming devices inside the tent. This includes candles, gas lanterns, kerosene lamps, stoves, cooking and heating appliances.
- Do not use gas appliances of any kind inside the tent/shelter.

TO PREVENT INJURY CAUSED BY FIRE

- Do not pitch the tent/shelter near a camp fire or any other flame source
- Do not use candles, matches or any other flame source in or near the tent (this includes stoves, cooking equipment, lighting and heating appliances)
- Only use recommended water repellent compounds on the tent/shelter fly
- Do not spray tent fabrics with insecticides



TO PREVENT INJURY CAUSED BY ELECTRICITY

- Always exercise care when using electricity and electric lighting in and near tents/shelters. Only use 12 volt lighting.



IMPORTANT SAFETY AND CARE INFORMATION CONT.

To prevent injury caused by your camping environment



- Do not pitch your tent/shelter on an area that could get flooded



- Do not pitch your tent/shelter near cliffs in case of collapse or rock fall



- Do not leave your tent/shelter erected in strong winds - collapse the tent onto the ground and seek refuge in your vehicle



- Do not pitch your tent/shelter under trees with dead branches or under trees known to drop branches

TENT POLE AND SHOCK CORD REPLACEMENT

Fibreglass Tent Pole

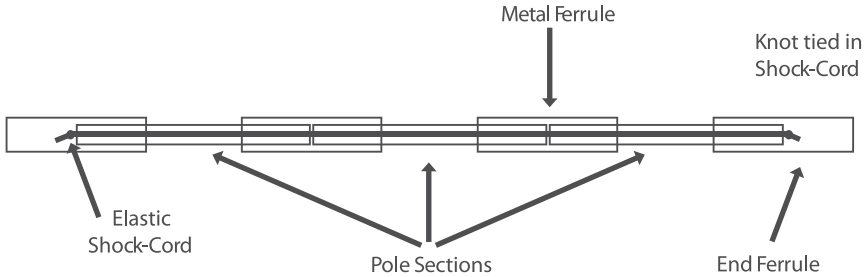

Figure 11

Tent poles and shock cord are similar to the tyres on your car, they require both maintenance and replacement from time to time after unexpected damage. Over stretching, dropping and age are the most common causes of shock cord failure. Excessive curvature during tent assembly or during periods of high winds is the most common causes of pole failure. By maintaining both the poles and shock cord you will be ensuring that you get the best performance and life out of your OZtrail tent.

HELPFUL HINT

To maximise the life of your shock cord never drop the tents poles during transporting. When packing poles into their carry bag be careful not to settle them by tapping them vertically on a hard surface.

REPLACING SHOCK-CORD

See Figure 11

Step One: Measure and Cut

Measure the length of the tent pole. You should use a length of shock cord roughly two-thirds the length of the tent pole. This will ensure that the shock cord has the appropriate amount of elasticity.

Step Two: Threading the Pole Sections

Tie a large knot in the end of the shock Cord length. This knot needs to be large enough to stop it passing through the tubular hole in the pole sections whilst you are threading it. Thread the shock Cord through the tubular hole in each pole section.

TENT POLE AND SHOCK CORD REPLACEMENT CONT.

HELPFUL HINT

Towards the end of the pole length it may get quite hard to thread the pole sections as the shock cord is stretching. To help avoid this, place all of the sections you have already threaded on the floor. Stretch the shock cord through them until you have much more than what you need for the rest of the sections to thread. Place your foot on the shock cord at the end of the last pole section you have threaded. This will maintain the stretch and give you plenty of shock cord to work with.

HELPFUL HINT

Be prepared for unexpected breakages, always carry a few spare pole sections that match the diameter of your tent poles as well as some lengths of replacement shock cord. These items are available at all good camping retailers.

Step Three: Tying Off

Once all of the pole sections have been threaded, you will need to tie a large knot in the shock cord, much the same as we did at the start. This knot needs to be sufficiently large to stop it pulling through the hole. Once this is done, trim the excess shock cord at each end.

Replacing Tent Pole Sections

Much like a flat tyre on your car, a broken pole section is an annoyance that can be easily rectified.

Cut the shock cord to enable you to remove the broken pole section. This is also a good time to replace the shock cord as well.

Measure both the diameter and overall length of the pole section. Once you have these measurements, you will be able to organise a pole replacement kit from your local camping goods retailer. You may have to cut the replacement pole to length. This can be done with a hack saw easily. Lightly sand the cut edge to remove any sharp edges.

Once your new pole is cut to length you can follow the 'Replacing Shock-Cord' directions to get your pole length complete.

UNDERSTANDING WATERPROOFNESS

Know your tent

OZtrail tents are manufactured from waterproof and water repellent fabrics. However, with the addition of seams, zips and other desirable features a recreational tent will not be as waterproof as a car, house or other solid structures.

The following are common examples of how water can enter a tent: -

CONDENSATION

When warm moist air meets cooler air, condensation occurs. The tent/shelter fly forms an impermeable layer between the inside and outside conditions. The moisture inside the tent/shelter condenses on the fabric. Sometimes in cold conditions it appears that the fabric is leaking when in fact the cause is condensation.

Condensation can be reduced if the tent/shelter is well ventilated.

ZIPS

All care is taken in the design to cover zips. At times wind driven rain could force water under the flaps and through the zips. To minimise this, make sure all doors and windows are closed with the flaps covering the zips.

FLOOR

If the ground is very wet or water pools under the floor, downward pressure of standing or kneeling on the floor could force water through the floor fabric. To prevent this, do not pitch the tent over hollows and make sure water drains away from the tent.

STRUCTURAL INTEGRITY

A well pitched tent on level ground is structurally strong and most waterproof. During prolonged periods of rain and wind it may be necessary to tighten guy lines and reset the tent pegs and attend to drainage around the tent. Sagging and incorrect pitching weakens the tent structure and could allow water to pool on the fly placing undue forces on the tent causing leaking and breakages.

REDUCING THE RISK OF JAMMING FABRIC IN THE ZIP

- When using the zip, hold the pull-tab between your thumb and forefinger with your thumb facing you.
- As you are closing the zip clear the way in front and under the zip slider using the back of your hand, and cup the zip slider underneath with your remaining 3 fingers.

Use this action for opening or closing. Keep the fabric clear of the zip slider - zip and unzip slowly.

WHAT TO DO IF THE ZIPPER GETS CAUGHT

- Pull the fabric bit by bit out of the slider. Do not try and pull all the fabric in one go. Do not force the slider or the fabric.

IF THE SLIDER DOES NOT CLOSE THE ZIPPER PROPERLY

- With use, the jaws of the zip slider can open ever so slightly. When this occurs the slider does not compress the zip teeth or coil together tightly enough and the zip bursts open or does not close.
- Undo the zip and with the slider at the end of the zip lightly crimp the jaws of the slider together. Try top to bottom axis first and then side to side axis.

CRIMPING A ZIP-SLIDER

The most common reason why zips burst open is that the zip slider does not close the coil tightly enough. Wear and tear may cause the gap marked A to open up.

See Figure 12.

By simply 'crimping' the slider together at points B & C with a pair of pliers, this solves the problem most of the time. Crimping in other planes is worth a try if B & C does not work. This is to be done when the zip slider is still attached to the zip in the open position. See Figure 12.

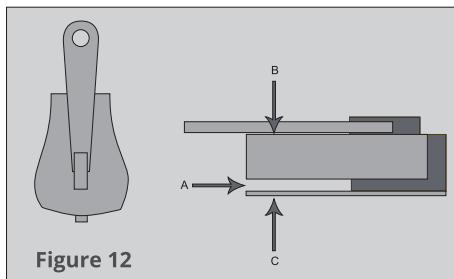

Figure 12



See our website for the full OZtrail range or

 facebook.com/OZtrailAustralia.

Made in China
Designed & Imported by:
OZtrail Leisure Products
71 Charles Ulm Place, Eagle Farm
QLD 4009, AUSTRALIA

www.oztrail.com