



Owners Manual

Camper Trailer



Camper 6

Camper 7

Outer Ridge Quest

Outer Ridge Venturer

CCT-06-E

CCT-07-E

CCT-ORQ-E

CCT-ORV-E

Ridgeline Zenith

Ridgeline Latitude

CCT-RLZ-E

CCT-RLL-E

www.oztrail.com.au

Contents

Products and Parts	5
Attaching to Trailer Instructions	8
Set Up and Assembly Instructions	13
Disassembly and Folding Instructions	23
Warranty.....	25
Prolonging the life of your Camper Trailer Tent	26
Important Safety and Care Information	28
Understanding Waterproofness and seasoning your canvas.....	30
Zips Care and Maintenance.....	31

HELPFUL HINTS

OZtrail advises to read the owner's manual fully before assembling and setting up your Camper Trailer Tent. Before your first camping trip ensure all parts are present and become familiar with the set up and fold away of your Camper Trailer Tent.

Camper Trailer Tent Features:

- The ultimate home away from home, OZtrail Camper Trailer Tents fit straight onto your own trailer and sets up in no time at all. At your favourite beach or in the middle of the outback,

the Camper Trailer Tent delivers comfort and style. The following is the list of OZtrail Camper Trailer Tent features. Please note, not all features are available on all models. Please consult your local OZtrail Dealer or www.oztrail.com.au for latest specification details.

- SatProof™ 600+ Canvas Walls are a heavy weight 340gsm blended Ripstop cotton canvas. The anti-mildew water proofing agent is saturated throughout the canvas before manufacture so even after wear and tear it will still provide a waterproof barrier. SatProof 600+ Canvas™ offers a minimum of 600 mm hydrostatic water head creating a waterproof canvas that still minimises condensation build up. The structure of cotton allows water vapour molecules to pass through and at the same time provide a barrier to water droplets.
- Silver coated SatProof 800+ Canvas :trademark: Roofs are a 340gsm blended cotton canvas. In a similar process to SatProof 600+ Canvas :trademark: this fabric is treated further to provide 800mm hydrostatic water head and maintains the same level of breathability. After weaving the fabric is rolled under pressure to accept the silver coating that blocks out more than 98% of UV radiation and heat. The technology used in this protective coating has been developed to provide a level of finish never seen before in a canvas product.
- Puncture resistant PVC vinyl flooring is standard on Camper 6, 7 and Outer Ridge models. Both Ridgeline models include the added feature of an invisible bucket floor to raise floor-wall junction above the ground.

- Heavy gauge hot dipped galvanised poles and reinforced corner pegs ideal for beach use.
- Zip off removable front awning with optional at extra charge 3 in 1 Draft-block sunroom and vinyl floor. Campers include a canvas tailgate cover to offer a complete seal when the sunroom and vinyl floor is included.
- Bedroom privacy with a tie back hanging room divider included (Removable canvas wall with mesh door on Ridgeline models).
- Optional rear room on Ridgeline models. This room is created by a zip on rear roof and frame with canvas walls and PVC floor.
- Multiple large windows and doors provide excellent ventilation.
- All weather fresh air ventilation with zip-out gusseted rear window on all Outer Ridge and Ridge line models.
- Large zip close shade awning over doors for added weather security.
- Sturdy No 10 coil door zips for easy access. DuoDoor™ allows single zip entry through mesh and canvas doors.
- Total insect control with No-See-Um mesh.
- Open cell foam mattress for support and comfort with removable polyester/cotton cover for easy washing.
- Easy access to bedroom platform with ladder included.
- Convenient internal access to the trailer storage area via under mattress trap door. Outer Ridge and Ridgeline models include a gas strut support.
- Full tilt feature for external access to trailer contents with gas strut supports on all Outer Ridge and Ridgeline models.
- All fitting hardware for trailer attachment included.
- Convenient internal lantern loop on all models
- To keep all accessories organised a carry bag for the pegs, ropes and awning poles is included.
- During storage and transporting the PVC dust cover with shock cord tensioners keeps your camper trailer tent clean, dry and secure. An additional zip off feature is included on all Outer Ridge and Ridgeline models.
- For further protection from the elements all Outer Ridge and Ridgeline models feature OZtrail's double layer roof with Insulcell insulated lining.
- 2 year manufacturer's warranty

Product Code:

CCT-06-E

CCT-07-E

CCT-ORQ-E

CCT-ORV-E

CCT-RLL-E

CCT-RLZ-E

Thank you for purchasing a quality OZtrail Camper Trailer Tent.

Please keep this OWNER'S MANUAL in a safe dry place as it contains important and helpful information.

This booklet contains instructions to help you mount the Camper Trailer Tent onto a trailer as well as set up and fold away instructions and many helpful hints to ensure you get the best from the Camper Trailer Tent.

The Camper Trailer Tent is easily mounted on a trailer by the average handyman with the help of 3 friends for lifting and positioning onto the trailer. Many trailer builders will mount the Camper Trailer Tent as part of the service when buying a trailer.

In this booklet you will find a number of sections that relate to the Camper

Trailer Tent use. These sections have details relating to parts lists, maintenance hints and information relating to the use of the Camper Trailer Tent. In particular OZtrail recommends that you read the sections relating to SAFETY PROCEDURES and Warranty conditions.

It is important that before you begin to assemble the Camper Trailer Tent you unpack the fittings supplied and familiarise yourself with the location and application of each part.

Once the Camper Trailer Tent has been mounted on a trailer we recommend that you set it up to familiarise yourself with the product and to make any adjustments that may be necessary. This will also help to make you comfortable with pitching and folding of the Camper Trailer Tent when you get to the camp site.

During this process it is also recommended that the canvas on the Camper Trailer Tent be "seasoned", to do this, please see the separate section on seasoning your canvas under the contents list.

Camper Trailer Tent Parts Description

- 1 x Camper Trailer Tent
- 1 x Awning pole kit
- 1 x Peg and rope kit
- 1 x Mattress
- 1 x Ladder
- 1 x Sunroom (Outer Ridge Venturer and Ridgeline Zenith)
- 1 x Sunroom vinyl floor (Outer Ridge Venturer and Ridgeline Zenith)

Fitting Parts Description for Camper Trailer tent Camper 6 and Camper 7.

- 6 x Bolts
- 6 x Washers
- 6 x Nuts
- 2 x Rope Hooks

Fitting Parts Description for Camper Trailer tent models Outer Ridge Quest, Outer Ridge Venturer, Ridgeline Latitude, Ridgeline Zenith and Camper trailer tent models Camper 6 and Camper 7 with optional gas tilt attachment kit.

- 2 x Clamping Latch mounted on bracket, As indicated in Figure 1.

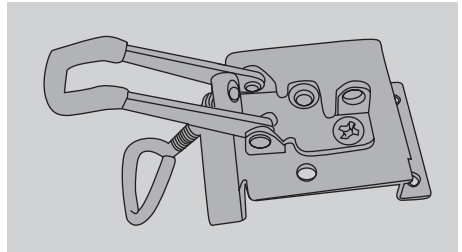

Figure 1

- 2 x Backing Plate, As indicated in Figure 2.

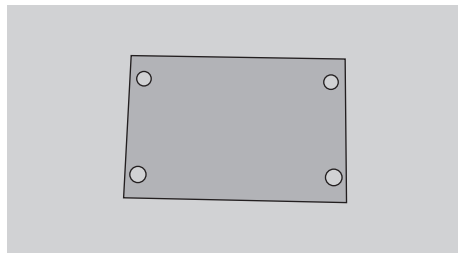

Figure 2

Fasteners included – 4 x 25/8mm hex-head bolts, 4 x 15/8mm gripper washers, 8 x 15/8mm washers, 4 x 13/8mm anti-slip nut with nylon insert.

HELPFUL HINT

The mounting bracket has been designed to either fit on flat metal or metal with corrugations. The bracket spans most corrugations. The latch can be locked with a padlock. Please note, padlocks are not included.

- ✓ 2 x Catch Hook for Clamping Latch, As indicated in Figure 3.

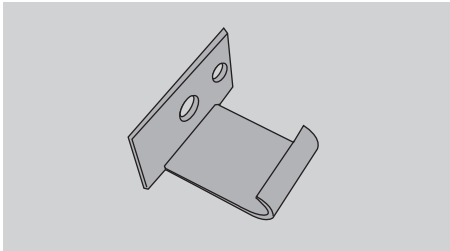

Figure 3

Fasteners included – 1 x 35/8mm dome-head bolts, 1 x 15/8mm gripper washers, 1 x 30/8mm washers, 1 x 15/8mm washers, 1 x 13/8mm anti-slip nut with nylon insert, 1 x 20mm screw.

- ✓ 2 x Stainless Steel Hinge mounted on bracket, As indicated in Figure 4.

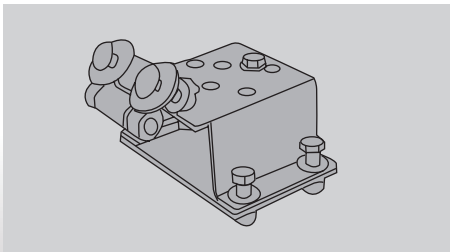

Figure 4

2 x Backing Plate, As indicated in Figure 2.

Fasteners included – 4 x 25/8mm hex-head bolts, 2 x 35/8mm dome-head bolts, 6 x 15/8mm gripper washers, 10 x 15/8mm washers, 2 x 30/8mm washers, 6 x 13/8mm anti-slip nut with nylon insert.

- ✓ 2 x Large Gas Strut to lift the entire base-board, As indicated in Figure 5.

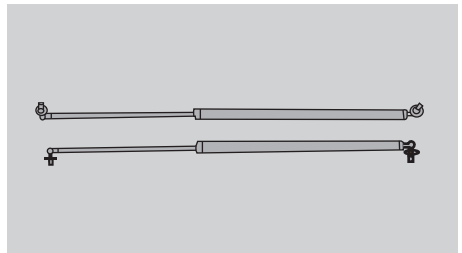

Figure 5

- ✓ 4 x Angle mounting brackets, As indicated in Figure 6.

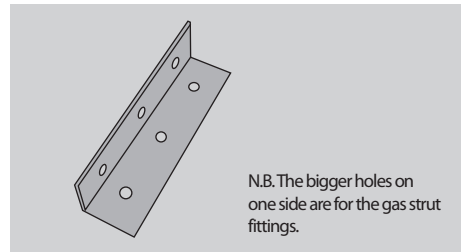

Figure 6

Fasteners included with struts



1 x Small Gas Strut to lift internal under mattress door, As indicated in Figure 7.

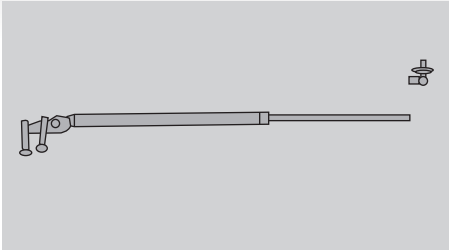

Figure 7



1 x Angle mounting bracket, As indicated in Figure 6. Fasteners included with strut



4 x Shock Cord Keepers, As indicated in Figure 8.

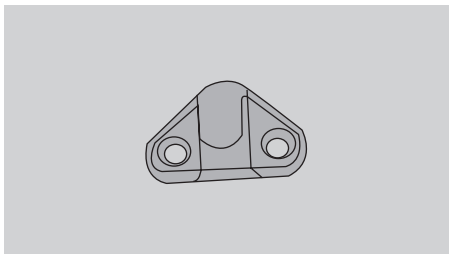
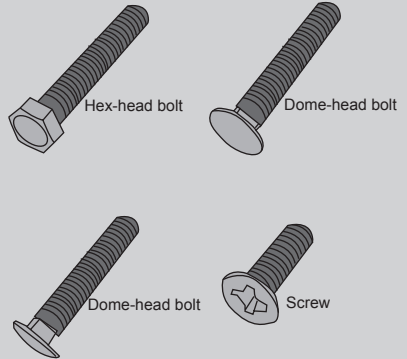

Figure 8

Fasteners included, screws x 2 per keeper

Fastener identification and names



PLEASE NOTE

Due to our policy of continual product development, specifications, parts and features of the Camper Trailer Tent models may vary from details within this owner's manual.

HELPFUL HINT

We recommend that you attach the Camper Trailer Tent to a trailer and set up the Camper Trailer Tent with a generous amount of time before you leave for a trip. Check that all parts are present and that you familiarise yourself with the assembly, set up and fold away procedures of the Camper Trailer Tent. If you have any questions, your OZtrail dealer will be happy to help you.

Attaching the Camper Trailer Tent to trailer Instructions

CAMPER TRAILER TENT PLACEMENT ON TRAILER

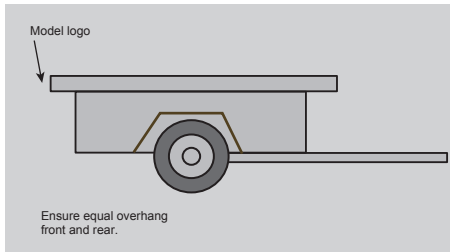
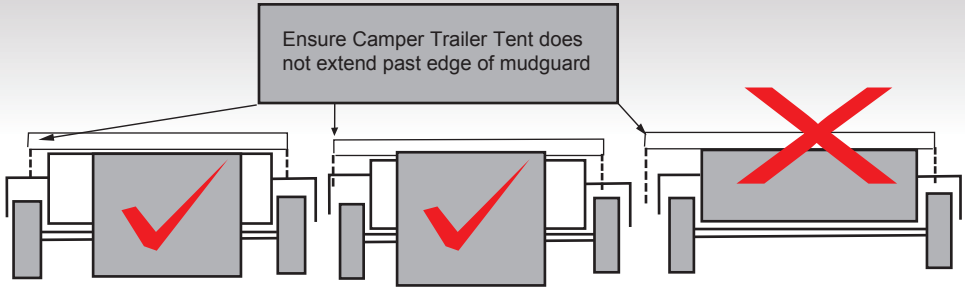

Figure 9

Tools you will need

- Drill
- 8mm drill bit for wood and steel.
- Spanners to fasten bolts and nuts.
- Large Phillips screwdriver.
- Foam sealing tape (optional at owner's decision and expense)

Step 1 Foam dust seal

Please note the dust seal is optional and not included. Glue a foam dust seal onto the top rim of your trailer. The top rim of most trailers is approximately 5cm wide and it is best to position the dust seal in the centre.

Step 2 Place the camper trailer tent onto your trailer

HELPFUL HINT

To avoid the risk of injury you should employ the help of at least three others to lift your Camper Trailer Tent onto the trailer and position it.

Firstly, stabilise and level your trailer, making sure it will not move as you work on it. With your three helpers lift the Camper Trailer Tent onto the trailer. The Camper Trailer Tent needs to be placed so that it folds out to the side of the trailer. Using a tape measure centralise the Camper Trailer Tent on the trailer with equal overhang at the front and rear of the trailer, as indicated in Figure 9. Always lift the Camper Trailer Tent, do not slide it otherwise this could damage the finish on the top rim of the trailer or the dust seal if fitted.

Attaching the Camper Trailer Tent to trailer Instructions

HELPFUL HINTS

1. The Camper Trailer Tent must fit within the total width of the trailer. It must not overhang the mudguards.
2. The rear of Camper Trailer Tent (the end nearest the tailgate) has the model name on the PVC dust cover.
3. Ensure that the Tailgate door when opened allows free access to the tailgate of your trailer and does not catch on the Camper Trailer Tent dust cover.

Step 3 Identify all parts

Locate the bags containing awning poles, pegs, ropes and attachment hardware inside the Camper Trailer Tent. Using the check list on page 5, identify all parts making sure all are present and where each will be fitted. Depending on the model of Camper Trailer Tent As indicated in Figure 10 or Figure 11.

Camper Trailer Tent 6 & 7 pole list

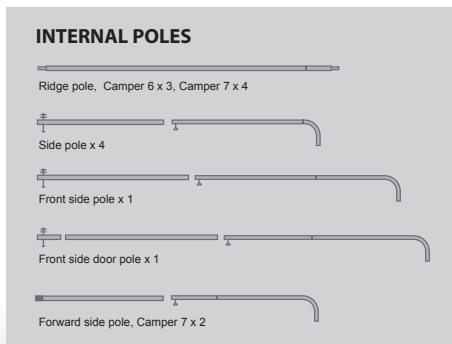

AWNING POLES

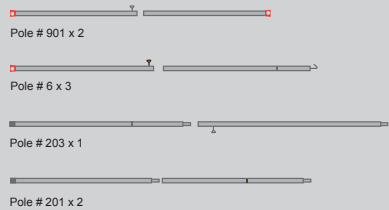
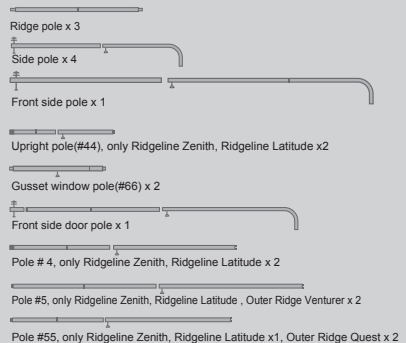

Figure 10

Camper Trailer Tent models Outer Ridge Quest, Outer Ridge Venturer, Ridgeline Latitude and Ridgeline Zenith pole list.

INTERNAL POLES



AWNING POLES

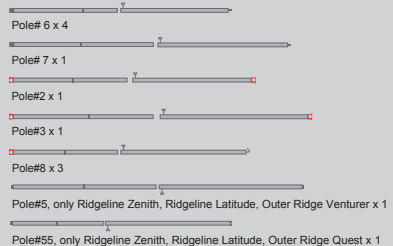

Figure 11

Attaching the Camper Trailer Tent to trailer Instructions

Step 4 Preparing to attach the timber base board to the trailer

Open out the Camper Trailer Tent to allow you access to the top-side of the baseboard. Unzip the doors to prevent suction when raising the Camper Trailer Tent and remove the mattress to prevent any damage that might occur during fitting. Have your friends hold both sides of the Camper Trailer Tent down to reduce the chance of it moving or tipping during the opening process.

For Camper Trailer Tent models Outer Ridge Quest, Outer Ridge Venturer, Ridgeline Latitude and Ridgeline Zenith or models Camper 6 and Camper 7 where optional gas tilt attachment kit has been purchased proceed to Step 5.

For Camper Trailer Tent models Camper 6 and Camper 7 without the optional gas tilt attachment kit, included are 6 x bolts, 6 x washers and 6 x nuts. Drill a total of 6 holes in the timber base board and through the top rim of the trailer. The 6 holes are made up of 2 holes (1 hole approximately 20-30cm from the front and 1 hole approximately 20-30cm from the rear) along each side and 2 holes evenly spaced across the front, as indicated in Figure 12. Position the 2 rope hooks on the rear tailgate, locate the position for the rope hooks that will allow adequate tension of the shock cord rope from the vinyl dust cover, as indicated in Figure 13.

HELPFUL HINT

As part of a regular maintenance schedule, check all nuts and bolts that connect the Camper Trailer Tent to the trailer are firmly secure and remain tight.

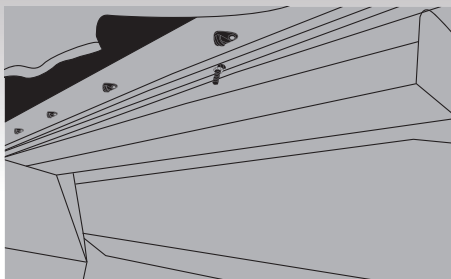

Figure 12



Figure 13

Step 5 Attaching the hinges

Attach the hinges and backing plate to the trailer, these should be approximately 20-30cms from the front and 20-30cm from the rear of the trailer on the left hand side while looking forward towards the tow hitch. Holes will have to be drilled into the trailer wall and the ply timber base board. Use fasteners and backing plate as your template for the hole position for the hinge brackets on the trailer. Use the actual hinge as the template for the hole position in the base-board, as indicated in Figure 14.

Attaching the Camper Trailer Tent to trailer Instructions

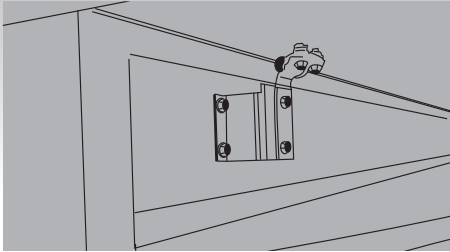

Figure 14

Step 6 Attaching the latches

Study the position of the catch-hook that is attached to the timber baseboard, the latch position on the trailer is required to line up exactly with the catch-hook. Attach both latch and backing plates to the trailer, these should be approximately 20-30cm from the front and 20-30cm from the rear of the trailer on the right hand side while looking forward towards the tow hitch. Here again use the backing plate as the template for the hole positions. Once this is in place align the position of the catch-hook that is attached to the timber base board, as indicated in Figure 15.

For Camper Trailer Tent models Camper 6 and Camper 7 with the optional gas tilt attachment kit, position the 2 rope hooks on the rear tailgate, locate the position that will allow adequate tension of the shock cord rope from the vinyl dust cover, as indicated in Figure 13.

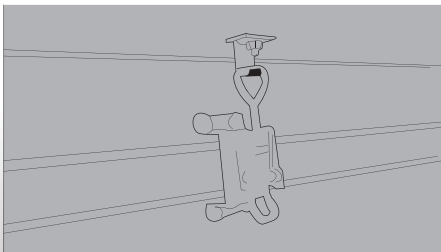

Figure 15

Step 7 Attaching the two large gas struts

Fitting position for the two large gas struts for Camper Trailer Tent models Outer Ridge Quest, Outer Ridge Venturer, Ridgeline Latitude and Ridgeline Zenith or models Camper 6 and Camper 7 when optional gas tilt attachment kit is purchased, as indicated in Figure 16.

Bolt on the gas strut angle mounts to the underside of the base board using the pre drilled holes. Attach the gas strut to the angle mount. Open the Camper Trailer Tent base to the desired height and angle required and secure with a temporary support, as indicated in Figure 17. It is recommended to position the base of the gas strut with the cylinder at the top to ensure that the piston is continually lubricated during use, as indicated in Figure 18. For the remaining end of the gas strut, select 2 of the remaining angle mount brackets and attach them inside the trailer side wall to align with the unattached end of the gas strut. Attach the gas strut to the mounted angle bracket, as indicated in Figure 16 to indicate the approximate position of the angle mount bracket on the inside side wall of the trailer. Please note the side of the angle mount brackets with the large diameter holes is to attach to the gas strut, the side with the smaller diameter holes attaches to the side wall of the trailer.

Attaching the Camper Trailer Tent to trailer Instructions

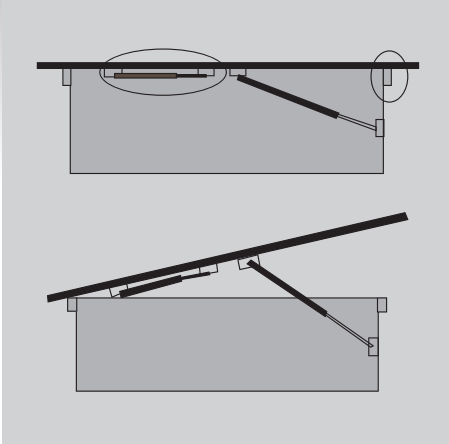

Figure 16

HELPFUL HINT

For safety, ensure the Camper Trailer Tent cannot accidentally close during fitting the gas struts by propping it up securely during this procedure, as indicated in Figure 17.

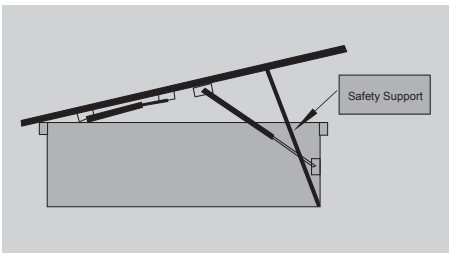

Figure 17

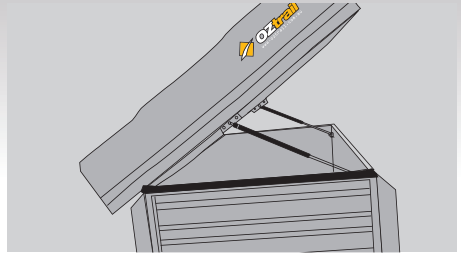

Figure 18

Step 8 Attaching the single small gas struts

The small strut is for the under mattress trailer access door that is located inside the Camper Trailer Tent. Attach the angle bracket beside the divider of the steel frame. Then attach the other end to the trap door while the trap door is open. The strut will compress when it closes, see Figure 19 showing the assembled strut position.

HELPFUL HINT

As part of a regular maintenance schedule, check all nuts and bolts that connect the camper trailer tent to the trailer are firmly secure and remain tight.

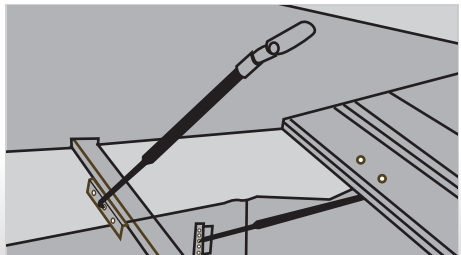

Figure 19

Set up and Assembly Instructions

HELPFUL HINT

OZtrail recommends two people are required to set up and assemble the Camper Trailer Tent. OZtrail recommends that you do this at least once before you embark on your first camping trip to allow for any adjustments that may need to be done and to ensure you are comfortable with the setup of your Camper Trailer Tent.

Step 1 Choose a level site

Select a sheltered camp site protected from the wind that will not allow water to pond under the tent floor. Clear the level area of all stones, twigs etc. When reversing ensure that all is clear behind and under the trailer. Once in the desired location, secure your trailer. Make sure that the jockey wheel and rear stabilizing legs are lowered and in place securely to prevent the trailer from becoming unstable or tipping. Adjust the jockey wheel and rear stabiliser to make sure the trailer is sitting level front to back and level side to side. Also chock the front and rear of both wheels to stop any movement.

HELPFUL HINT

Always carry several hardwood ground plates (approximately 400mm long x 200mm wide x 40mm thick) to use as support blocks for your rear stabilisers and front jockey wheel on those occasions when you are camped on soft or sandy ground. These ground plates are also handy as a jack base when changing tyres or for levelling the trailer wheels on uneven ground.

Step 2. Locate accessories including poles, peg and ropes.

Unpack poles, ropes and tent pegs from the trailer and identify each piece and where each goes, depending on model see Figure 21 and 22.

Camper Trailer Tent 6 & 7 pole list

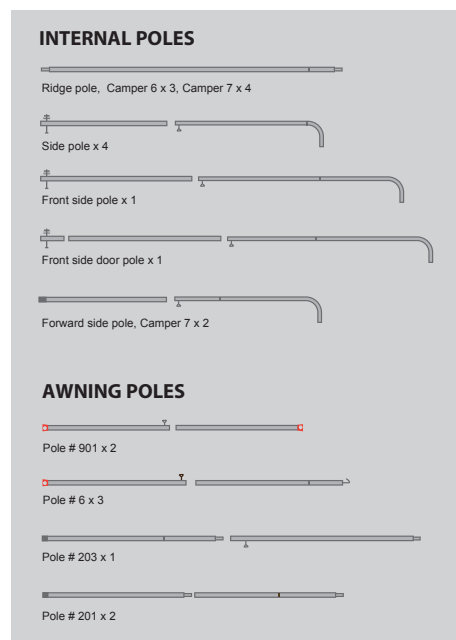

Figure 20

Set up and Assembly

Instructions

Camper Trailer Tent models Outer Ridge Quest, Outer Ridge Venturer, Ridgeline Latitude and Ridgeline Zenith pole list.

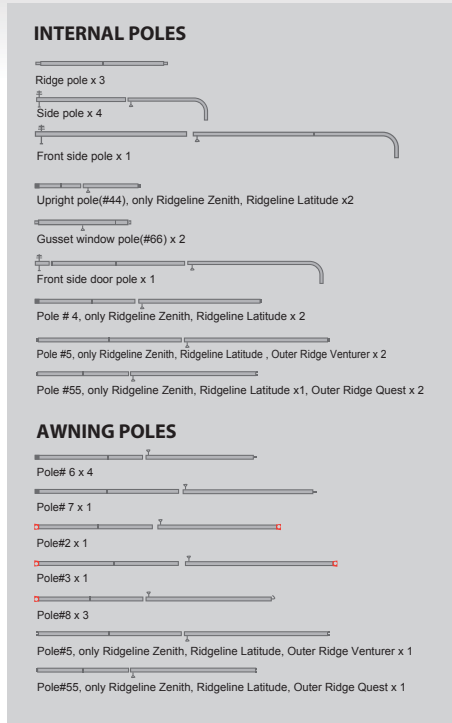

Figure 21

Step 3 Remove the dust cover

For Camper Trailer Tent models Camper 6 & Camper 7, release shock rope and roll forward the dust cover making sure to secure it in case of wind or rain. OZtrail does not recommend removing the dust cover from sail track because if it is not correctly refitted to the sail track, air can enter into dust cover with great force when towing and cause damage.

For Camper Trailer Tent models Outer Ridge Quest, Outer Ridge Venturer, Ridgeline Latitude and Ridgeline Zenith, release the shock rope and unzip to remove the dust cover and place it folded in a safe place, OZtrail recommends inside the trailer.

Step 4 Standing up the Camper Trailer Tent

Standing at the side of the trailer, unfold the Camper Trailer Tent to the left. Have your friend stand on the other side of the trailer to help unfold the Camper Trailer Tent. This process can be made much easier by firstly partially undoing the door zippers to allow air inside the Camper Trailer Tent to prevent suction while it unfolds.

HELPFUL HINT

For Camper Trailer Tent models Camper Trailer Tent models Outer Ridge Quest, Outer Ridge Venturer, Ridgeline Latitude and Ridgeline Zenith to help stand up the tent, release the two side latches holding the Camper Trailer Tent base to the trailer and allow the Camper Trailer Tent base to tilt on the trailer using the hinges and gas struts. Once the Camper Trailer Tent is unfolded lower the Camper Trailer Tent base again and fasten latches securely.

Set up and Assembly Instructions

Step 5 Peg out the Camper Trailer Tent

Close the doors completely. Peg out the corners of the Camper Trailer Tent. For peg point locations, as indicated in Figure 22. Anchor the tent to the ground by inserting the pegs through the loops around the base of the tent at an angle of 45 degrees, firm but not tight, As indicated in Figure 23. Start with the corner peg points along the trailer edge. As you work from one peg point to the next around the tent base pull the floor firm, but not tight. Ensure all peg down points are utilised and where applicable the length of the webbing loops is correctly adjusted.

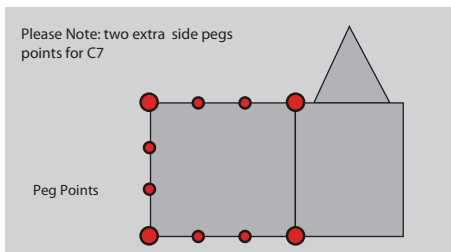

Figure 22

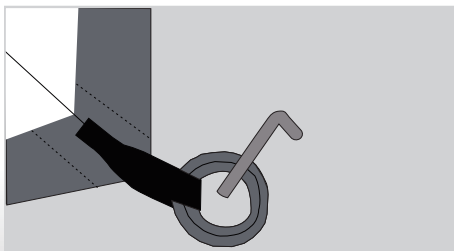

Figure 23

Step 6 Camper Trailer Tent frame adjustment and assembly

Check again the trailer is level and secure, by repeating Step 1 above. Now unzip the door access under the awning and walk inside the Camper. Note that the steel hoop pole frames radiate from hub plates at each front corner of the timber base board.

During the first set up, it will be necessary to adjust all the main hoop pole frames' height and tension.

Firstly, get up onto the bed platform and extend the adjustable trailer side poles on each side of the bed platform until they pull the front wall up firmly, as indicated in Figure 24 (page 21). Next, extend the adjustable centre side poles on each side of the bed platform to pitch the roof firmly, as indicated in Figure 24 (page 21).

HELPFUL HINT

Apart from minor adjustments from time to time these hoop pole frames above the bed platform should not require regular tensioning on future camping trips.

Set up and Assembly

Instructions

Now get down from the bed platform and onto the vinyl floor at ground level. Extend the adjustable front side pole and front side door pole, this will tension the roof and walls until firm. If required the front side door poles over the doorway can be removed from the hub plate by releasing the locking pin and then extend the front side door pole towards the rear wall and locate the end of the front side door pole into the pocket provided on the floor next to the door, as indicated in Figure 24 (page 21). To avoid damage, it is important to re-attach the front side door pole to the hub plate before folding up the Camper Trailer Tent.

Due to the extended length of the ground level room, on Camper Trailer Tent model Camper 7 an additional steel hoop pole is supplied to support and tension the rear wall and roof area, this hoop pole is made up of the forward side and ridge poles, as indicated in Figure 24 (page 21). The forward ridge poles are inserted into the canvas pole sleeve along the wall and roof junction, the forward ridge pole can remain in this sleeve. Next connect the forward side poles to the forward ridge pole and secure the other end of the forward side poles into the pocket provided on the floor and wall junction. Finally adjust the height of forward side poles to allow the roof and rear wall to become firm and create a uniform roof slope to allow water to run off without ponding.

For Camper Trailer Tent model Outer Ridge Quest, OZtrail provides two spreader pole #55 with "C" clips at each end to strengthen the structure of the roof frame, as indicated in Figure 24 (page 22).

For Camper Trailer Tent model Outer Ridge Venturer, OZtrail provides two spreader poles #5 with "C" clips at each end to strengthen the structure of the roof frame, as indicated in Figure 24 (page 22).

For all Camper Trailer Tent models Ridgeline Zenith and Ridgeline Latitude, OZtrail provides two spreader poles #5 with "C" clips at each end to strengthen the structure of the roof frame. Two poles #4 are provided as support legs for the front ridge pole in the roof. Two poles #44 are provided as support for the trailer ridge poles, as indicated in Figure 24 (page 22).

Set up instructions for the Camper Trailer Tent awning and optional rear room

This is best done with the help of a friend, but if you follow the instructions closely in conjunction with the hints below you should be able to erect the awning alone.

Step 1 Identify the poles

Camper Trailer Tent models 6 & 7, as indicated in Figure 24 (page 21)

- 3 x Ridge poles with bent spigot one end and flattened and drilled on the other end (#6)
- 1 x Long pole with straight spigot (#203)
- 2 x Poles with straight spigot (#201)
- 2 x Spreader poles with two flattened ends (#901)

Camper Trailer Tent Outer Ridge Quest, as indicated in Figure 24 (page 21).

- 3 x Ridge poles with bent spigot one end and flattened and drilled on the other end (#8)
- 1 x Long pole with straight spigot (#7)
- 4 x Poles with straight spigot (#6), including 2 x awning poles for rear door
- 1 x Spreader pole with two flattened ends (#3)
- 1x Long spreader pole with two flattened ends (#2)
- 1 x Spreader poles with "C" clips each end (#55)

Camper Trailer Tent Outer Ridge Venturer, as indicated in Figure 24 (page 21).

- 3 x Ridge poles with bent spigot one end and flattened and drilled on the other end (#8)
- 1 x Long pole with straight spigot (#7)
- 4 x Poles with straight spigot (#6), including 2 x awning poles for rear door
- 1 x Spreader pole with two flattened ends (#3)
- 1x Long spreader pole with two flattened ends (#2)
- 1 x Spreader poles with "C" clips each end (#5)

Camper Trailer Tent models Ridgeline Zenith and Ridgeline Latitude, as indicated in Figure 24 (page 22).

- 3 x Ridge poles with bent spigot one end and flattened and drilled on the other end (#8)
- 1 x Long pole with straight spigot (#7)
- 4 x Poles with straight spigot (#6), including 2 x awning poles for rear door
- 1 x Spreader pole with two flattened ends (#3)
- 1x Long spreader pole with two flattened ends (#2)
- 1 x Spreader poles with "C" clips each end (#5)
- 1 x Spreader poles with "C" clips each end (#55)

Rear room option for Camper Trailer Tent models Ridgeline Zenith and Ridgeline Latitude, as indicated in Figure 24 (page 22).

- 2 x Ridge poles with bent spigot one end and flattened and drilled on the other end (#8)
- 1 x Long pole with straight spigot (#7)
- 1 x Poles with straight spigot (#6)
- 1x Long spreader pole with two flattened ends (#2)
- 1 x Spreader poles with "C" clips each end (#5)

HELPFUL HINT

Layout each pole in its approximate position and insert the corner tent rope pegs, only peg them half way into the ground as you need to move them later. Attach the guy ropes to the pegs for quick attachment to poles later.

Set up instructions for the Camper Trailer Tent awning

Step 2 Attach the ridge poles to the frame of the Camper Trailer Tent

For Camper Trailer Tent models 6 & 7, place the bent spigot of the ridge poles (#6) and for all Camper Trailer Tent models Outer Ridge and Ridgeline place the bent spigot of the ridge poles (#8) through the Eye Bolts at the points adjacent to the inner frame poles on the outer wall of the Camper Trailer Tent leaving them hanging in place, as indicated in Figure 25 (page 22).

Step 3 Assembling the centre ridge and upright poles.

For Camper Trailer Tent models 6 & 7, place the eye end of the middle ridge pole (#6) over the spigot tip of the long pole (#203) and get your friend to hold pole (#203).

Using the thicker end of pole (# 901) and making sure the adjustment screw is facing down, place the eye of spreader poles (#901) over the spigot of pole (#203). Place the eyelet in the middle of the canvas awning over the spigot of pole (#203) and adjust the ridge pole (# 6) till the canvas is tight. Raise pole (#203) to approximately the height required and place the loop of the guy rope over the spigot, tightening the ropes enough to hold the pole.

For all Camper Trailer Tent models Outer Ridge and Ridgeline, place the eye end of the middle ridge pole (#8) over the spigot (point) of the long pole (#7) and get your friend to hold pole (#7). Using the thicker end of poles (#2) & (#3) and making sure the adjustment screw is facing down, now place the eye of spreader poles (#2

& (#3) over the spigot of pole (#7), make sure you position the long pole on the long side of the awning. Place the eyelet in the middle of the canvas awning over the spigot of pole (#7) and adjust the ridge pole (#8) until the canvas is tight. Raise pole (#7) to approximately the height required and place the loop of the guy rope over the spigot, tightening the ropes enough to hold the pole.

HELPFUL HINT

Place the loop of a spare guy rope over the spigot of the centre upright pole to hold the eyelet down so that the canvas does not pop off the spigot while you continue with the side ridge pole assembly. This can be tied to the pole below the adjustment nut or fixed to the adjustment nut.

Step 4 Assembling the side ridge and upright poles.

For Camper Trailer Tent models 6 & 7, place the eye of one of the spreaders poles (#901) and the corresponding side ridge pole (#6) over a corner pole (#201) spigot, now place the corner eye of the canvas awning over the spigot and adjust the length of both poles to pull the canvas tight. Raise the pole (#201) to the approximate height and place the loop of the guy rope over the spigot, tightening the ropes enough to hold the pole. Repeat the above process for the remaining side ridge and upright poles.

For all Camper Trailer Tent models Outer Ridge and Ridgeline, place the eye of one of the spreaders poles (#2 or 3) and the corresponding side ridge pole (#8) over a corner pole (#6) spigot, now place the corner eye of the canvas awning over the spigot and adjust the length of both poles to pull the canvas tight. Raise the pole (#6) to the approximate height and

Set up instructions for the Camper Trailer Tent awning

place the loop of the guy rope over the spigot, tightening the ropes enough to hold the pole. Repeat the above process for the remaining side ridge and upright poles. Now select the long spreader pole (#5) (use pole (#55) for Outer Ridge Quest) and position between the centre ridge and the side ridge parallel to pole (#2), as indicated in Figure 24.

Step 5 Level ridge poles, check all peg points, tension awning and guy ropes

Ensure all ridge poles are horizontal and the upright poles are vertical. Adjust all poles and ropes to tighten the canvas, now attach Velcro™ tabs located on the underside awning roof around the poles. At this point you should determine whether pegs for the guy ropes are positioned correctly and make any adjustments necessary to the guy rope angle and peg location. For the correct position of the guy ropes, make a loop (about 30-50 cm long) with the slider on the end of the rope and peg out as far as possible from the pole, as indicated in Figure 27. Ensure all peg points around the base of the Camper Trailer Tent are utilised and all guy ropes are attached firmly and remain firm.

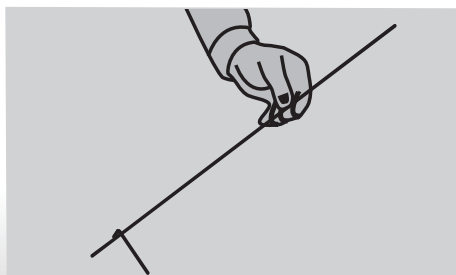

Figure 27

PLEASE NOTE

If the awning is not tensioned correctly, water can pond during rain and may cause damage to the roof fabric and poles. This damage is not covered by the OZtrail warranty.

HELPFUL HINT

It is a good idea to have all poles adjusted to the approximate length required before you begin to assemble the awning. After the first assembly and final adjustments are made, with a felt pen mark each pole at the adjusted length for future reference. This will allow you in future to adjust and set the poles close to the correct length before setting up the awning. Some minor adjustments will still need to be made but it will help with setting up the awning and make it quicker.

Step 6 Installing gusseted bedroom window awning poles

If required select the two poles #66, adjust length to fit into the corner eyelet on the bedroom window awning and the opposite end of the pole fits into the eyelet along the base of the camper tent. If tensioned correctly the window awning will remain in the open position in light wind conditions without the need for guy ropes.

Step 7 Attaching the optional sunroom and optional sunroom floor

If you have purchased the OZtrail 3 in 1 sunroom option, it simply attaches by way of a continuous Velcro™ strip running up the side of the main Camper Trailer Tent walls and around the inside of the awning roof edge. Starting at one corner work your way around the awning roof by simply aligning and attaching the Velcro™ strips

Set up instructions for the Camper Trailer Tent awning

provided, patting the two halves together as you go to ensure good contact. When the roof connection is complete, attach the Velcro™ to the walls of the Camper Trailer Tent. The sunroom is a unique 3 in 1 design that allows each of the three sunroom walls to be used individually for privacy or a wind break or can be used as one to form an additional room.

You will find a number of webbing loops provided to enable you to peg the walls down to the ground. Firmly, but not tight, insert a peg at each point to secure the sunroom walls.

If you have purchased the OZtrail sunroom floor option, it attaches to the base of the Camper Trailer Tent and sunroom walls by a continuous Velcro™ strip. Starting at one corner work your way around the base of the walls by simply aligning and attaching the Velcro™ strips provided, patting the two halves together as you go to ensure good contact.

Step 8 Attaching the optional rear room with frame, roof, walls and floor

If you have purchased the OZtrail rear room option, it simply attaches to the rear of the main Camper Trailer Tent following a similar process to steps 2 to 5 above.

Unfold the rear room roof and align zipper ends with zipper along rear roof edge of the main Camper Trailer Tent. Zip zipper together. Select the two ridge pole (#8) and place the bent spigot of the ridge pole (#8) through the Eye Bolts at the points adjacent to the inner frame poles on the rear outer wall of the Camper Trailer Tent leaving them hanging in place, as indicated in Figure 26 (page 22). Now place the eye end of the middle ridge pole (#8) over the spigot (point) of the long pole (#7) and get your friend to hold pole (#7).

Using the thicker end of pole (#2) and making sure the adjustment screw is facing down, now place the eye of spreader pole (#2) over the spigot of pole (#7). Place the eyelet in the top of the canvas awning over the spigot of pole (#7) and adjust the ridge pole (#8) until the canvas is tight. Raise pole (#7) to approximately the height required and place the loop of the guy rope over the spigot, tightening the ropes enough to hold the pole. Next place the eye of one of the spreaders poles (#2) and the corresponding side ridge pole (#8) over a corner pole (#6) spigot, now place the corner eye of the canvas awning over the spigot and adjust the length of both poles to pull the canvas tight. Raise the pole (#6) to the approximate height and place the loop of the guy rope over the spigot, tightening the ropes enough to hold the pole. Now select the spreader pole (#5) and position between the centre ridge and the side ridge parallel to pole (#2), as indicated in Figure 26 (page 22). Ensure all ridge poles are horizontal and the upright poles are vertical. Adjust all poles and ropes to tighten the canvas, now attach Velcro™ tabs located on the underside awning roof around the poles. At this point you should determine whether pegs for the guy ropes are positioned correctly and make any adjustments necessary to the guy rope angle and peg location. For the correct position of the guy ropes, make a loop (about 30-50 cm long) with the slider on the end of the rope and peg out as far as possible from the pole, as indicated in Figure 27. Ensure all peg points around the base of the Camper Trailer Tent are utilised and all guy ropes are attached firmly and remain firm.

PLEASE NOTE

If the awning is not tensioned correctly, water can pond during rain and may cause damage to the roof fabric and poles. This damage is not covered by the OZtrail warranty.

HELPFUL HINT

It is a good idea to have all poles adjusted to the approximate length required before you begin to assemble the awning. After the first assembly and final adjustments are made, with a felt pen mark each pole at the adjusted length for future reference. This will allow you in future to adjust and set the poles close to the correct length before setting up the awning. Some minor adjustments will still need to be made but it will help with setting up the awning and make it quicker.

PLEASE NOTE

In severe conditions the Camper Trailer Tent should be dismantled and packed away.

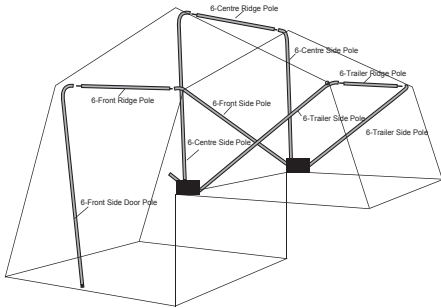

Camper Trailer Tent 6 tent poles

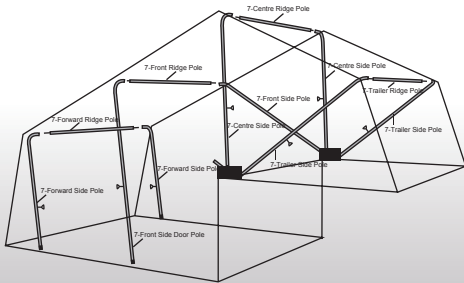

Camper Trailer Tent 7 tent poles

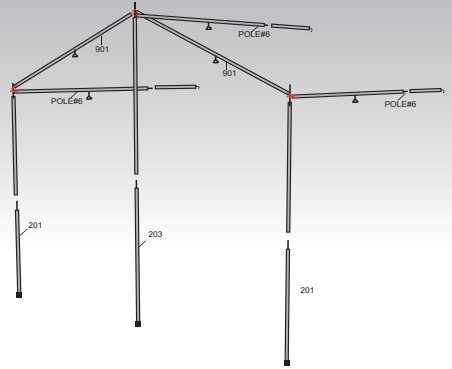

Camper Trailer Tent 6 & 7 awning poles

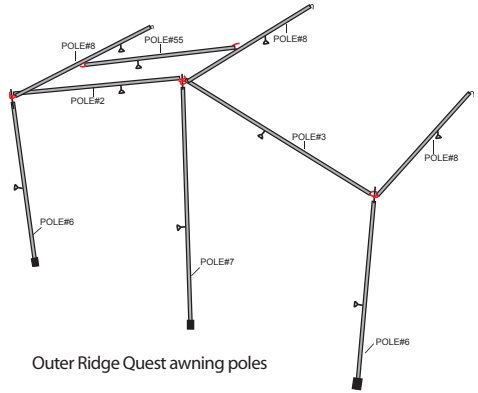

Outer Ridge Quest awning poles

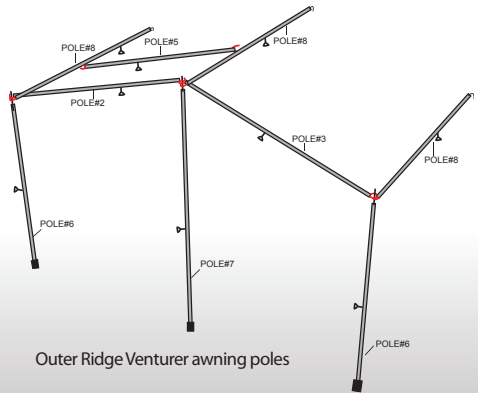

Outer Ridge Venturer awning poles

Figure 24

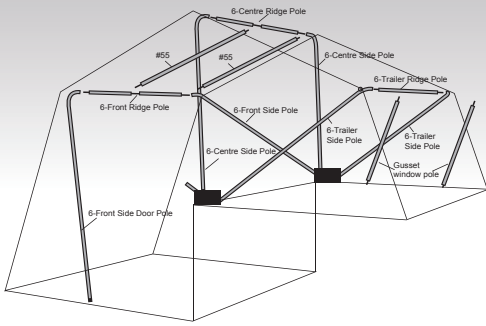

Outer Ridge Quest tent poles

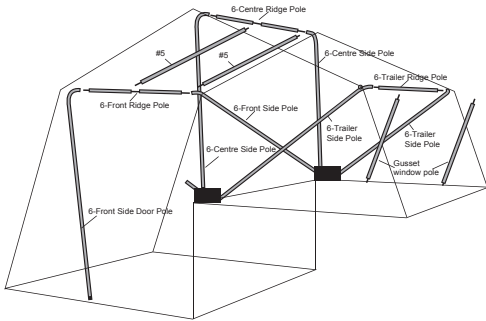

Outer Ridge Venturer tent poles

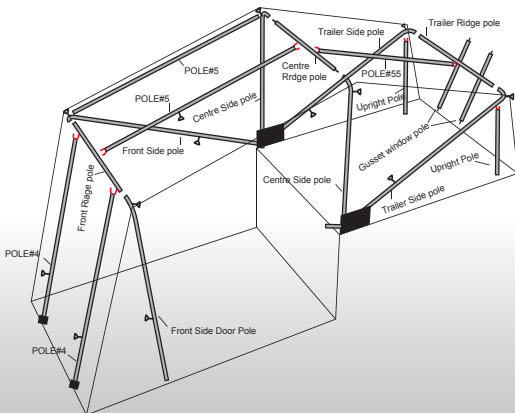

Ridgeline Latitude, Ridgeline Zenith tent poles

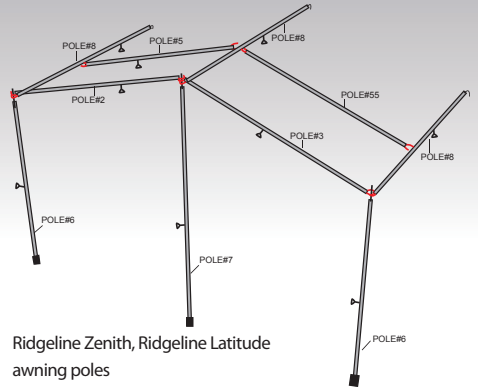

Ridgeline Zenith, Ridgeline Latitude awning poles

Figure 24 continued

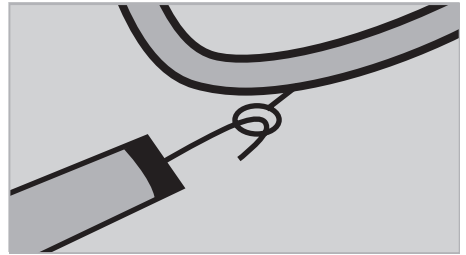
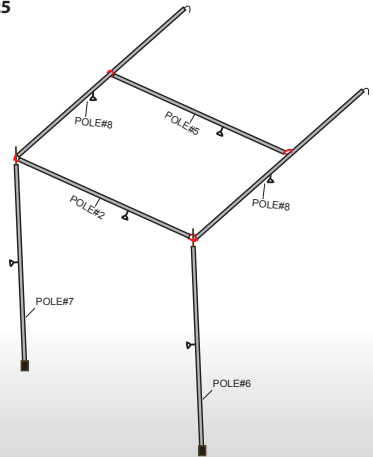

Figure 25



Outer Ridge Quest rear room poles

Figure 26

Disassembly and Folding instructions

HELPFUL HINT

OZtrail recommends two people are required to pack away the Camper Trailer Tent. It is a good idea to include a dustpan and brush in your camping kit to clean the floor before packing it away. It is also helpful to remove any tree leaf or debris from the roof before folding.

Step 1

Close all windows, awning and doors not needed for folding the camper. If present, remove rear room walls and floor as well as the front sunroom floor and walls by following the reverse order of the assembly instructions. Lay them on the ground and fold in half, third or quarters. The width of the folded sunroom floor or walls should be the length of their carry bag, as indicated in Figure 28.

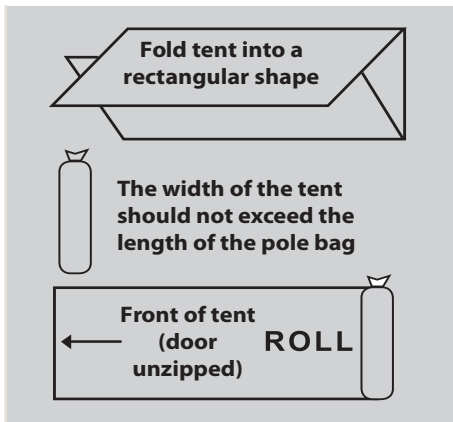

Figure 28

Step 2

Release and remove any spreader poles #5 and #55 (with "C" clips at each end) that have been used to brace the awning and the main frame. Release and remove any window poles #66 and upright support poles #4 and #44 that were used. Place the poles into the pole carry bag. Release the Posibrace Velcro tab points that attach the awning roof to the poles.

Step 3

Inside the Camper Trailer Tent, replace the front side door poles into the hub plate on the bed base making sure they are properly clipped into place and undo the zips in the vinyl wall adjacent to the hub plates.

Step 4

Remove all guy ropes and tent pegs with a claw hammer or peg puller and put them into their bag.

Step 5

Collapse the awning frame by removing and disassembling the poles in the reverse order of the assembly instructions. Place the poles in the pole carry bag and tie shut.

Step 6

Fold the awning back over the top of the main Camper Trailer Tent.

HELPFUL HINT

Use a ridge pole with the hooked spigot placed into the corner eye of the awning to raise the awning roof up and carefully draw it over the top of the Camper Trailer Tent. Do this slowly to avoid snagging the awning roof and causing any damage.

Step 7

For Camper 7 only, release the tension bolt on the forward side poles and remove the forward side poles and place these poles into the pole carry bag. The forward ridge pole can remain in the pole sleeve, as indicated in Figure 24, from the previous Set up and Assembly Instructions section.

Release the tension bolt on the front side/door poles and allow the telescopic poles retract to their minimum length. Allow a portion of the door to remain unzipped to allow air trapped in the Camper Trailer Tent to escape during folding.

Disassembly and Folding instructions

Step 8

With the help of a friend, starting with the trailer pole, followed by the central pole, fold the hoop pole frames down one at a time taking care to tuck and fold the canvas within the edges of the Camper Trailer Tent base. While using only a slight amount of force try and flatten and fold the canvas evenly as much as possible as this will assist you when fitting the dust cover.

Step 9

For Camper Trailer Tent models 6 & 7 only, unroll the vinyl dust cover attached to the front of the Camper Trailer Tent and position the vinyl dust cover evenly over the folded Camper Trailer Tent. Connect the side and rear shock cord rope to the hooks under the Camper Trailer Tent base and across the rear tail gate to evenly tension the vinyl dust cover.

For all Camper Trailer Tent models Outer Ridge Quest, Outer Ridge Venturer, Ridgeline Latitude and Ridgeline Zenith, position the vinyl dust cover over the folded Camper Trailer Tent making sure the zip connecting position is aligned. Engage the zipper and after zipping pat down the Velcro™ to ensure weather protection is complete. Connect the side shock cord ropes to the hooks under the Camper Trailer Tent base to evenly tension the vinyl dust cover.

HELPFUL HINT

Never store a Camper Trailer Tent damp or dirty. If you have no choice to return home from your camping trip with a damp or dirty tent, make sure you open it out to air in a cool, dry and shaded place as soon as possible and only pack it away when it is completely dry and clean.

Step 10

Once the Camper Trailer Tent is folded and secured with the vinyl dust cover, place poles, ropes, pegs in their respective carry bags, owner's manual and other miscellaneous parts into the trailer. Make sure that the exposed nuts, bolts and brackets inside the trailer cannot damage any of your packed gear inside the trailer. Close and lock both latches that secure the Camper Trailer Tent to the trailer.

HELPFUL HINT

Latches which are not closed correctly may open in transit and could cause damage. By purchasing and placing a small padlock in the loop provided on each latch, this possibility is eliminated and your trailer contents are secured.

Step 11

As a final safety check before transporting the trailer, ensure the rear stabiliser check before transporting the trailer, ensure the rear stabiliser legs have been folded up, check that the front jockey wheel is stowed correctly for towing, the safety chain is connected to the towing vehicle and lights are connected and are all working correctly. Make sure the dust cover is secure around the entire perimeter of the trailer. On long journeys, stop periodically to check the dust cover and all nuts and bolts are secure.

HELPFUL HINT

OZtrail recommends that an additional tie down strap be placed over the Camper Trailer Tent when travelling. Firstly they reduce the stress on the latches and hinges as well as the nuts and bolts from vibrations when travelling on rough roads. Secondly they reduce the ballooning effect that the wind has on the dust cover which cuts down drag and saves fuel.

Warranty

OZtrail warrants this product against defects for a period of two years from the date of purchase. OZtrail will repair or replace the product, at its discretion, should a warrantable defect arise within the warranty period. If the exact model is unavailable a model of equivalent nature will be substituted at our discretion. This warranty excludes faults and failures caused by improper use and abuse; fair wear and tear; or failure to follow instructions regarding care and maintenance. Products used for a commercial nature are not covered by this warranty against defects. A warranty may be claimed by returning the product to its place of purchase, with a detailed proof-of-purchase clearly showing the date and detail of the purchase. You may also contact OZtrail Leisure Products, by phone: 07 3279 1800, or in writing: PO Box 1, Sumner Park DC, 4074, QLD, by email: warranty@oztrail.com.au. The benefits under OZtrail's warranty against defects are in addition to other rights and remedies under law in relation to goods.

Our goods come with guarantees that cannot be excluded under the Australian Consumer Law. You are entitled to a replacement or refund for a major failure and for compensation for any other reasonably foreseeable loss or damage. You are also entitled to have the goods repaired or replaced if the goods fail to be of acceptable quality and the failure does not amount to a major failure.

For more detailed information and an explanation of these terms as indicated in www.oztrail.com.au/warranty

PLEASE NOTE

Accessories shown may be for display purposes only and not included with the product. Due to our policy of continual product development, specification and features of this product may vary from what is stated.

HELPFUL HINT:

AVOIDING MOULD AND MILDEW

You should always pack the Camper Trailer Tent away both clean and completely dry. In many climates there is a risk of mould and mildew damage to materials that are not packed away in a dry state, this condition is not covered by the warranty. After each camping trip, clean the Camper Trailer Tent fabric with warm soapy water and allow it to dry completely after rinsing with fresh water.

Prolonging the Life of your Camper Trailer Tent - Care Instructions

Please note OZtrail recommends temporary use only. Although our fabrics are treated for extra UV resistance, continuous exposure to sun light will reduce the life of the fabric. Fading of colour is an early warning sign. OZtrail products are not designed as permanent dwellings or structures.

During rain always check the roof and awning remains firm and tight as any un-tensioned canvas will cause water ponding and potential leaking or damage and this condition is not covered by warranty. The most common cause of water ponding on the roof is an uneven camp site and incorrect pole adjustment. To help correct for an uneven campsite the purchase of extra spreader poles #55 and # 5 and extra height support poles # 4, can help reduce water ponding. During heavy rain OZtrail recommends you lower the awning and in severe conditions the Camper Trailer Tent should be dismantled and packed away.

Never store a wet or soiled Camper Trailer Tent, as mildew and corrosion can form very quickly and this condition is not covered by the warranty. Always allow the Camper Trailer Tent to dry completely before packing away and storage. If you are forced to pack up wet or dirty canvas always ensure the Camper Trailer Tent is set up as soon as possible and thoroughly cleaned and dried before storage. To clean your canvas, gently dampen and wash with a circular motion with a soft brush or cloth. Take care with the scrubbing and the detergent as both can have an effect on the water-proofing of the canvas. After beach use or wet weather it is important to treat

all zips, poles and pegs with silicon spray. Caution, cleaners that use bleach as an ingredient should not be used. Bleach can cause fading and lead to damage of the canvas fabric, the stitching and the waterproofing.

The pole joiners within the poles are provided for easy assembly of the frame. The pole joiners are not required for any structural reason and the poles perform perfectly well without the pole joiners. Age, over-stretching and mishandling may cause failure. Pole joiners are not covered by warranty.

Sometimes the zipper coil bursts open or does not close. This could be due to wear or metal fatigue. The problem can be easily fixed. See instructions on page 31.

Always carry a roll of heavy duty tape for simple repairs to small rips, cuts and ash burns. The tape not only blocks the hole, it will minimise any further tearing.

When removing pegs do not use the webbing attached to your Camper Trailer Tent as a handle. Either use another peg, a peg remover or the claw of a hammer hooked under the peg to remove them. A couple of taps with a hammer on the side of the peg or some twisting will often help release the peg from the ground.

Prolonging the Life of your Camper Trailer Tent - Care Instructions

HELPFUL HINTS:

CONDITIONING THE CAMPER TRAILER TENT.

Once you get the new Camper Trailer Tent home, it is important to condition the fabric. Once installed, simply set up the Camper Trailer Tent and wet it down thoroughly with a garden hose until the fabric and all seams are saturated. Pay particular attention to the seams – the thread swells when wet and blocks the needle holes. The canvas fabric also benefits from this wetting and drying because the cotton swells into the weave and the waterproof treatment settles within the fabric. Let the Camper Trailer Tent dry completely before repeating the wetting and drying cycle. Keep repeating the wetting and drying process until there is no leakage during the hosing phase. Always make sure the Camper Trailer Tent is completely dry before packing it away.

If you need to store your Camper Trailer Tent for an extended period of time, OZtrail recommends that it should be stored out of the weather. If a roofed shelter is not possible, a tarpaulin will help reduce the sun's effect on the dust cover, reduce water pooling on it and minimise organic matter and dirt from gathering on the dust cover that promote mould growth and attract insects. OZtrail recommends that you open and set up the Camper Trailer Tent to air at least once a month.

Materials:

Pole – Steel

Bed base - Timber

Tent – PVC floor with polyester/cotton wall and roof

CARING FOR YOUR GALVANISED STEEL POLES, POLE JOINERS AND ZIPS

Your OZtrail steel poles have been hot dip galvanised to provide long life with minimum corrosion. Salt, sand, dirt and water are the enemy of any steel product and zip. Make sure the poles and zips are always clean and dry before storage. When the poles and zips have been used in damp, dusty, sandy or salty conditions they must be cleaned and coated with a thin film of oil or silicon based liquid spray before storage.

Many of the frame poles are connected with pole joiners which are designed to keep your poles organised and to allow quick assembly of the pole frame. Over stretching or dropping the poles will easily damage the pole joiners and this is not covered by the warranty. Please make sure you handle the poles carefully, especially when unpacking and packing away into the carry bag. The impact of a pole hitting the hard ground can easily damage the pole joiners.

INSURANCE, YOUR PROTECTION AGAINST THE UNEXPECTED

Most people have product problems from unexpected sources. Extreme weather is a good example of an unexpected problem. Make sure that you list your expensive camping products on your home and contents insurance policy. Most good insurers will cover accidental and storm damage to your Camper Trailer Tent that falls outside this warranty.

Important Safety and Care Information

Please read before selecting a camp site and setting up your Camper Trailer Tent

CAMP SAFE - SAFETY HABITS

Fabric used in the construction of OZtrail Camper Trailer Tents has been treated with a mild retardant. This retardant treatment reduces the rate at which the fabric will burn, however the fabric will still burn if it comes into direct contact with a flame or heat source.

The application of any foreign substance to the fabric such as some water proofing treatments or insect sprays may render the fire retardant treatment process ineffective.

The following pages cover several safety tips that will help you avoid some of the common hazards encountered on a camping trip.

TO PREVENT INJURY CAUSED BY GAS POISONING OR SUFFOCATION

Gas, fumes or lack of oxygen within the Camper Trailer Tent could result in unconsciousness, brain damage and even death.

Always ensure the Camper Trailer Tent is well ventilated. Even on the coldest night do not close every vent, window and door. A well ventilated Camper Trailer Tent not only maintains healthy oxygen levels, but also reduces condensation build up on the inside of the fabric.

Do not use fuel burning devices that consume oxygen inside the Camper Trailer Tent. These include candles, gas lanterns, kerosene lamps, stoves, cooking and heating appliances.

Do not use gas appliances of any kind inside the Camper Trailer Tent.

TO PREVENT INJURY CAUSED BY FIRE

Do not set up the Camper Trailer Tent near a camp fire or any other flame source.

Do not use candles, matches or any other flame source in or near the Camper Trailer Tent. This includes stoves, cooking equipment, lighting and heating appliances.

Use only recommended non-flammable water repellent compounds on the canvas fabric.

Do not spray canvas fabrics with insecticides.



TO PREVENT INJURY CAUSED BY ELECTRICITY

Always exercise care when using electricity and electric lighting in and near the Camper Trailer Tent. Only use 12 volt or less for lighting.



Important Safety and Care Information cont.

To prevent injury caused by your camping environment



Do not pitch the Camper Trailer Tent on an area that could be flooded



Do not pitch the Camper Trailer Tent near a cliff base in case of collapse or a rock fall



Do not leave the Camper Trailer Tent set up in strong winds – pack away the Camper Trailer Tent and seek refuge in your vehicle



Do not set up the Camper Trailer Tent under trees with dead branches or under trees known to drop branches

Understanding Waterproofness

Know your Camper Trailer Tent

OZtrail Camper Trailer Tents are manufactured from waterproof and water repellent fabrics. However, with the addition of seams, zips and other desirable features a recreational Camper Trailer Tent cannot be as waterproof as a car, house or other solid structures.

The following are common examples of how water can enter a Camper Trailer Tent.

CONDENSATION

When warm moist air meets cooler air, condensation of water gas into water liquid occurs. The Camper Trailer Tent walls and roof form an impermeable layer between the inside and outside climatic conditions. The moisture inside the tent condenses on the canvas fabric and water droplets are formed. Sometimes these water droplets build up to appear that the fabric is leaking when in fact the cause is condensation. Condensation can be reduced if the Camper Trailer Tent is well ventilated to reduce the build-up of warm moist air on the ceiling.

ZIPES

All care is taken in the design to cover zips with storm flaps or position them where water will not flow. At times wind driven rain could force water under the flaps and through the zips. To minimise this, make sure all doors and windows are closed with flaps securely covering the zip wherever possible.

FLOOR

If the ground is very wet or water pools under the floor, then the downward pressure of standing or kneeling on the floor can draw water through minute wear holes in the floor fabric or where there are joins in the floor fabric. To prevent this, do not set up the Camper Trailer

Tent in hollows and make sure water drains away from the tent site.

STRUCTURAL INTEGRITY

A well set up Camper Trailer Tent on level ground is structurally strong and the most waterproof. During periods of prolonged rain and wind it may be necessary to tighten and adjust the frame, pegs and guy ropes as well as making sure any ground water is flowing away from the camp site. A sagging roof or awning weakens the Camper Trailer Tent structure and could allow water to pond on the roof causing leakage, structural damage and fabric tears.

CONDITIONING THE CANVAS FABRIC

A new or recently detergent cleaned Camper Trailer Tent requires conditioning. Simply set up the Camper Trailer Tent and wet it down thoroughly with a garden hose until the fabric and all seams are saturated. Pay particular attention to the seams – the thread swells when wet and blocks the needle holes. The canvas fabric also benefits from this wetting and drying because the cotton swells into the weave and the waterproof treatment settles within the fabric. Let the tent dry completely before repeating the wetting and drying cycle. Keep repeating the wetting and drying process until there is no leakage during the hosing phase. If after wetting and drying cycles there is still some leakage a canvas sealing compound can be purchased from most camping stores, read the manufacturer's instructions carefully before using the canvas sealing compound. Always make sure the Camper Trailer Tent is completely dry before packing it away.

REDUCING THE RISK OF JAMMING FABRIC IN THE ZIP

When using the zip, hold the pull-tab between your thumb and forefinger with your thumb facing you.

As you are closing the zip, clear the way in front and under the zip slider using the back of your hand and cup the zip slider underneath with your remaining 3 fingers.

Use this action for opening or closing. Keep the fabric clear of the zip slider - zip and unzip slowly.

WHAT TO DO IF THE ZIPPER GETS CAUGHT

Pull the fabric bit by bit out of the slider. Do not try and pull all the fabric in one go. Do not force the slider or the fabric.

IF THE SLIDER DOES NOT CLOSE THE ZIPPER PROPERLY

With use the jaws of a zip slider can open slightly over time. This can be exaggerated quickly if fabric is caught into the zipper. When this occurs the slider does not compress and interlock zipper coil teeth tightly enough and the zip bursts open or does not close. To fix this, simply undo the zip and with the slider at the end of the zip lightly crimp the jaws of the zip slider together with a pair of pliers.

CRIMPING INSTRUCTIONS FOR A ZIP SLIDER

The most common reason why zips burst open is that the zip slider does not close the coil tight enough. Commonly wear and tear or fabric jamming will cause the gap marked "A" to increase, see Figure 29.

By gently "crimping" the slider together at points "B" and "C" with a pair of pliers, gap "A" can be adjusted most times to its correct opening, see Figure 29. Crimping in other planes is worth a try if "B" and "C" fails to rectify the problem. This crimping is done when the zip slider is still attached to the zip coil and is in the fully open position.

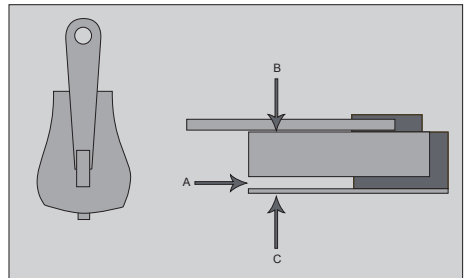

Figure 29

For other OZtrail products to choose from, see our website or  facebook.com/OZtrailAustralia.

